

University of Groningen

## Expediting workflow in the acute stroke pathway for endovascular thrombectomy in the northern Netherlands

Maas, Willemijn; Lahr, Maarten; Uyttenboogaart, Maarten; Buskens, Erik; van der Zee, D.J.

*Published in:*  
BMJ Open

*DOI:*  
[10.1136/bmjopen-2021-056415](https://doi.org/10.1136/bmjopen-2021-056415)

**IMPORTANT NOTE: You are advised to consult the publisher's version (publisher's PDF) if you wish to cite from it. Please check the document version below.**

*Document Version*  
Publisher's PDF, also known as Version of record

*Publication date:*  
2022

[Link to publication in University of Groningen/UMCG research database](#)

*Citation for published version (APA):*

Maas, W., Lahr, M., Uyttenboogaart, M., Buskens, E., & van der Zee, D. J. (2022). Expediting workflow in the acute stroke pathway for endovascular thrombectomy in the northern Netherlands: a simulation model. *BMJ Open*, 12(4), Article 056415. <https://doi.org/10.1136/bmjopen-2021-056415>

### Copyright

Other than for strictly personal use, it is not permitted to download or to forward/distribute the text or part of it without the consent of the author(s) and/or copyright holder(s), unless the work is under an open content license (like Creative Commons).





The publication may also be distributed here under the terms of Article 25fa of the Dutch Copyright Act, indicated by the "Taverne" license. More information can be found on the University of Groningen website: <https://www.rug.nl/library/open-access/self-archiving-pure/taverne-amendment>.

### Take-down policy

If you believe that this document breaches copyright please contact us providing details, and we will remove access to the work immediately and investigate your claim.

Downloaded from the University of Groningen/UMCG research database (Pure): <http://www.rug.nl/research/portal>. For technical reasons the number of authors shown on this cover page is limited to 10 maximum.

# BMJ Open Expediting workflow in the acute stroke pathway for endovascular thrombectomy in the northern Netherlands: a simulation model

Willemijn J Maas <sup>1,2</sup>, Maarten M H Lahr <sup>2</sup>, Maarten Uyttenboogaart <sup>1,3</sup>, Erik Buskens <sup>2,4</sup>, Durk-Jouke van der Zee <sup>2,4</sup> On behalf of CONTRAST investigators

**To cite:** Maas WJ, Lahr MMH, Uyttenboogaart M, *et al*. Expediting workflow in the acute stroke pathway for endovascular thrombectomy in the northern Netherlands: a simulation model. *BMJ Open* 2022;**12**:e056415. doi:10.1136/bmjopen-2021-056415

► Prepublication history and additional supplemental material for this paper are available online. To view these files, please visit the journal online (<http://dx.doi.org/10.1136/bmjopen-2021-056415>).

Received 19 August 2021  
Accepted 28 February 2022



© Author(s) (or their employer(s)) 2022. Re-use permitted under CC BY-NC. No commercial re-use. See rights and permissions. Published by BMJ.

For numbered affiliations see end of article.

**Correspondence to**  
Willemijn J Maas;  
[w.j.maas@umcg.nl](mailto:w.j.maas@umcg.nl)

## ABSTRACT

**Objective** The objective of this study is to identify barriers for the timely delivery of endovascular thrombectomy (EVT) and to investigate the effects of potential workflow improvements in the acute stroke pathway.

**Design** Hospital data prospectively collected in the MR CLEAN Registry were linked to emergency medical services data for each EVT patient and used to build two Monte Carlo simulation models. The ‘mothership (MS) model’, reflecting patients who arrived directly at the comprehensive stroke centre (CSC); and the ‘drip and ship’ (DS) model, reflecting patients who were transferred to the CSC from primary stroke centres (PSCs).

**Setting** Northern region of the Netherlands. One CSC provides EVT, and its catchment area includes eight PSCs.

**Participants** 248 patients who were treated with EVT between July 2014 and November 2017.

**Outcome measures** The main outcome measures were total delay from stroke onset until groin puncture, functional independence at 90 days (modified Rankin Scale 0–2) and mortality.

**Results** Barriers identified included fast-track emergency department routing, prealert for transfer to the CSC, reduced handover time between PSC and ambulance, direct transfer from CSC arrival to angiography suite entry, and reducing time to groin puncture. Taken together, all workflow improvements could potentially reduce the time from onset to groin puncture by 59 min for the MS model and 61 min for the DS model. These improvements could thus result in more patients—3.7% MS and 7.4% DS—regaining functional independence after 90 days, in addition to decreasing mortality by 3.0% and 5.0%, respectively.

**Conclusions** In our region, the proposed workflow improvements might reduce time to treatment by about 1 hour and increase the number of patients regaining functional independence by 6%. Simulation modelling is useful for assessing the potential effects of interventions aimed at reducing time from onset to EVT.

## INTRODUCTION

Acute ischaemic stroke places a large burden on society, and the overall incidence has increased by 78% since 1990.<sup>1</sup> The main reperfusion treatments for acute ischaemic

## Strengths and limitations of this study

- Data were collected on time delays along the acute stroke pathway for patients treated with endovascular thrombectomy (EVT), thereby allowing the identification, analysis and simulation of barriers from onset to treatment.
- An extensive set of workflow improvements is suggested based on data analysis, expert opinion and literature.
- A simulation model of the acute stroke pathway is developed, enabling the effective and efficient assessment of workflow improvements, relying on realistic in-silico modelling.
- The simulation model includes only patients treated with EVT in a region with one comprehensive stroke centre, but it could be extended to all suspected patients who had a stroke, thereby allowing a more comprehensive assessment of stroke care.

stroke due to large vessel occlusion are intravenous thrombolysis (IVT) and endovascular thrombectomy (EVT). The phrase ‘time is brain’ applies to both treatments. For EVT, the probability of regaining functional independence at 90 days after stroke declines by 5%–6% for each additional hour delay from onset to groin puncture (OTG).<sup>2,3</sup>

Successful and timely EVT largely depends on the regional organisation of acute stroke care delivery. Delays that can occur during prehospital and intrahospital processes, as well as along each step in the acute stroke pathway, have the potential to worsen patient outcomes or even rule out the possibility of acute treatment. Pathway elements that have been identified as having the potential to cause treatment delays include prehospital stroke management, in-hospital patient transfer, anaesthetic management, teamwork and inter-hospital patient transfer.<sup>4</sup>

Most studies of interventions aimed at improving workflow processes have focused on specific interventions, examining bits and pieces of the acute stroke pathway separately. The joint analysis of several improvements might lead to the identification of actual improvements. Simulation modelling has been suggested as a means of supporting such comprehensive analyses, and it has been performed within the context of IVT based on a variety of organisational models.<sup>5,6</sup>

The objectives of this study are (1) to assess delays in the workflow of acute stroke care, based on patient-level data; and (2) to estimate the impact of reducing delays throughout the process, from work-up to EVT treatment, based on simulation modelling.

## METHODS

### Setting

This study is based on prospective data collected in the MR CLEAN Registry<sup>7</sup> from patients treated with EVT in one comprehensive stroke centre (CSC), which provides EVT for eligible patients in the northern part of the Netherlands (1.7 million inhabitants). Its catchment area includes eight primary stroke centres (PSCs), spaced at distances of 6–84 km, as shown in online supplemental figure S1.

### Participants and data collection

Between July 2014 and November 2017, 285 patients were included. According to the emergency medical services (EMS) protocol,<sup>8</sup> patients suspected of acute stroke were routed to the nearest IVT-capable hospital. The patients were either sent directly to a CSC (mothership (MS) model) or first presented at a PSC and subsequently transferred to the CSC for EVT (drip and ship (DS) model). In the eastern part of the province of Groningen, patients were routed directly to the CSC, reflecting a centralised organisational model.<sup>9</sup>

Patient data on clinical characteristics, diagnostic processes, time delays and ambulance routing patterns were used as input for simulation modelling. In-hospital time delays included onset or time last seen well, CT, IVT initiation, CT angiogram (CTA), arrival at the angiography suite and the time of groin puncture. In-hospital (PSC or CSC) patients were routed through the emergency department (ED) according to three routes: (1) CT to IVT to CTA; (2) CT to CTA to IVT and (3) CT to CTA (patients ineligible for IVT). Following secondary transfer, DS patients arriving at the CSC could undergo additional diagnostics (eg, CT and/or CTA).

Prehospital data from three EMS organisations were collected retrospectively and linked to the MR CLEAN Registry data for each patient. Time-delay items collected included 911 notification, EMS arrival at the stroke-onset location, departure to hospital and arrival at hospital. Additional data collected for DS patients included the timestamps for EMS transfer notification, arrival at PSC, departure to CSC and arrival at CSC.

Patients were excluded from analyses in case of a prior modified Rankin Scale (mRS) >2 and when OTG exceeded 390 min, as EVT based on perfusion CT beyond 6 hours was not indicated at that time. Missing values were excluded from analyses.

### Patient and public involvement

No patients involved.

### Simulation

Separate Monte Carlo simulation models were developed for the MS and DS organisation models.<sup>10</sup> Prior to model building, conceptual modelling was performed in order to abstract real-world acute stroke pathways, as shown in figure 1. Conceptual models were validated using expert opinion (MU), combined with literature observations and input from stroke experts participating in the national collaboration for new treatments of acute stroke (CONTRAST) consortium.<sup>11</sup>

Both simulation models were developed using Plant Simulation.<sup>12</sup> Distributions for the individual time-delay variables were based on patient data and obtained using ExpertFit.<sup>13</sup> Details are presented as online supplemental tables 1 and 2.

### Modelling scenarios

We identified barriers along the acute stroke pathway by analysing patient data, relevant literature and expert opinion (MU). These barriers were used to create hypothetical scenarios, which we tested ‘in silico’ using the simulation model developed for this purpose.

### Outcome measures

Outcome measures include OTG, likelihood of functional independence (mRS 0–2) and mortality (mRS 6) at 90 days.

### Analysis

The simulation models were validated numerically by comparing mean, median, SD, minimum and maximum time values of real-world patient data and observations to model data and outputs.

Within the simulation model, ordinal logistic regression was used to estimate the likelihood of each of the seven scales belonging to the mRS score, ranging from 0 (no symptoms) to 6 (death). Known prognostic variables were OTG (continuous), age (continuous), National Institutes of Health Stroke Scale score (continuous) and CTA collateral grading score in four categories (absence of collaterals, less than 50% filling of the occluded area, more than 50% filling but less than 100% filling of the occluded area and 100% filling of the occluded area). The likelihood of functional independence (mRS 0–2) was calculated from the formulas obtained by ordinal logistic regression, using IBM SPSS Statistics V.23 software. Details are presented as online supplemental material 1.

For each scenario, we calculated the clinical benefits in terms of reduction in OTG and the likelihood of regaining

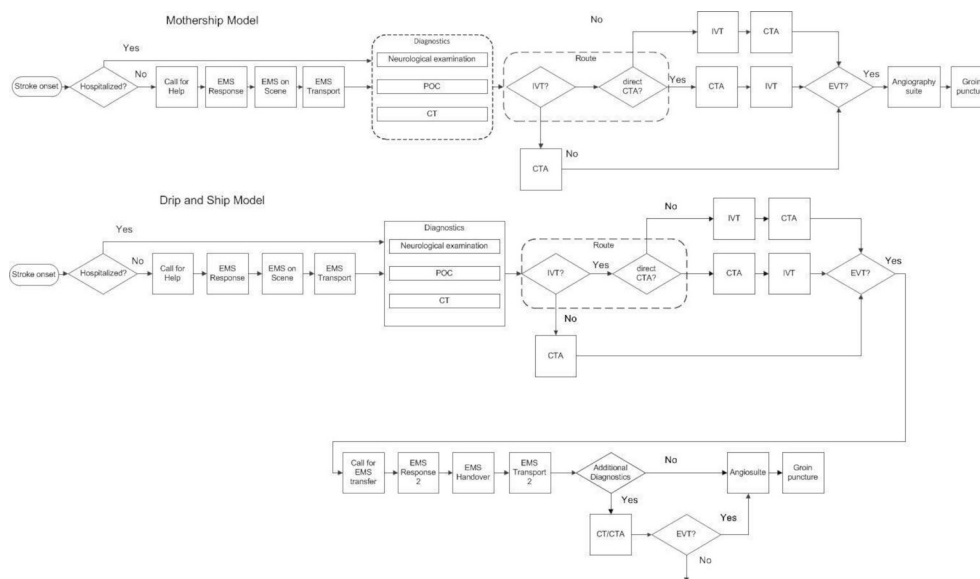

**Figure 1** Conceptual models of the acute stroke pathway: ‘mothership’ and ‘drip and ship’. CT, computed tomography; CTA, CT angiography; EMS, emergency medical services; EVT, endovascular thrombectomy; IVT, intravenous thrombolysis; POC, point of care.

functional independence and reducing mortality. Significance testing was inappropriate, as the goal was to assess the potential gain expected based on 100 000 hypothetical patients, rather than to test a hypothesis as in an actual experiment.

## RESULTS

In all, 248 patients met the inclusion criteria. Of these patients, 27 were excluded because of a prestroke mRS>2, and/or an unknown OTG of >390 min (12 patients). Patient characteristics, diagnostics and median time delays for each model are presented in table 1. For MS patients (n=83), the median (IQR) OTG was 205 (160–260) min; 51.8% regained functional independence after 90 days and mortality was 26.5%. For DS patients (n=165), the respective figures were 230 (198–275) min, 52.1% and 22.4%. To obtain the likelihood formulas for each of the seven mRSs, data from 80 MS patients and 154 DS patients were used. Despite faster OTG, the MS patients had a lower likelihood of functional independence and a higher likelihood of mortality after 90 days compared with DS patients.

### Identified delays

We identified multiple opportunities for improving workflow for both the DS and MS models.

#### DS model, PSC workflow

The door-in-door-out (DIDO) time was used to estimate the entire PSC workflow, defined as time from PSC arrival until departure to the CSC. The DIDO time of patients routed through the ED according to route 2 (CT to CTA to IVT) was less than that of patients routed according to route 1 (CT to IVT to CTA), with a mean (SD) of 82 (25) min versus 100 (37) min, respectively.

We also assessed the handover time from PSC to ambulance for transfer to the CSC. The lowest median (IQR) handover time in one of the PSCs was 11 (8–14) min, as compared with an overall median time of 14 (10–16) min.

#### DS model, CSC workflow

If no additional diagnostics are required, DS patients arriving at the CSC should be transferred directly to the angiography suite.<sup>14</sup> The observed median (IQR) transfer time from CSC arrival to angiography suite was 26 (16–38) min, and from angiography suite arrival to groin puncture 30 (24–35) min.

#### MS model, CSC workflow

We assessed the time from CSC presentation to arrival at the angiography suite for each route through the ED. Patients who were routed according to route 2 (CT to CTA to IVT) had shorter delays compared with those who were routed according to route 1 (CT to IVT to CTA); with a mean (SD) of 103 (46) min compared with 113 (42) min, respectively. The observed median (IQR) time from the last examination at the ED to angiography suite arrival was 58 (44–82) min, and between angiography suite arrival and groin puncture 28 (25–35) min.

### Modelling scenarios

The following scenarios were defined, based on the barriers identified for the DS model (online supplemental table S3): routing all patients without contraindication for IVT through the ED according to route 2 (CT to CTA to IVT) (scenario 1a); EMS prealert is used, thus reducing the ambulance response time to 0 min (scenario 1b); reducing the handover time from PSC to ambulance to 11 min (scenario 1c); and combining all three experiments (scenario 1d).

**Table 1** Characteristics, diagnostics and time delays of the MS and DS models

	MS model	n	DS model	n
<b>Patient characteristics</b>				
Age in years (SD)	65 (14)	83	70 (13)	165
Male (%)	39 (47)	83	99 (60)	165
IVT rate (%)	53 (64)	83	132 (80)	165
<b>Patient diagnostics</b>				
Baseline NIHSS score (IQR)	16 (11–19)	82	17 (12–19)	165
Collaterals absent or filling of less than 50% (%)	36 (45)	80	92 (60)	155
<b>Process times EMS</b>				
Symptom onset to 911 call	20 (6–63)	66	11 (3–33)	139
Response time	9 (7–12)	65	9 (7–12)	132
On-scene time	20 (16–26)	62	16 (12–20)	126
Transport time	17 (12–23)	61	12 (7–15)	122
<b>Process times in-hospital, PSC or CSC</b>				
Hospital arrival to CT	13 (11–17)	63	15 (11–20)	125
<b>Route 1</b>				
CT to IVT	10 (8–16)	23	8 (4–19)	56
IVT to CTA	10 (6–22)	23	11 (5–19)	57
<b>Route 2</b>				
CT to CTA	6 (5–10)	30	9 (5–11)	62
CTA to IVT	11 (7–18)	30	9 (4–15)	63
<b>Route 3</b>				
CT to CTA	7 (4–14)	29	14 (9–30)	31
<b>Process times EMS for transfer from PSC to CSC</b>				
Last examination ED (IVT or CTA) to 911 transfer call	NA		28 (15–44)	148
Response time	NA		8 (5–10)	140
Handover time	NA		14 (10–16)	139
Transport time	NA		27 (19–32)	150
<b>Process times in-hospital CSC</b>				
<b>Route additional diagnostics</b>				
CSC arrival to additional diagnostics	NA		23 (17–45)	17
Additional diagnostics to angiography suite	NA		29 (14–70)	18
Last examination ED to angiography suite	58 (44–82)	76	NA	
CSC arrival to angiography suite	107 (74–133)	60	26 (16–38)	151
Arrival angiography suite to groin puncture	28 (25–35)	77	30 (24–35)	163
<b>Overall time</b>				
OTG	205 (160–260)	83	230 (198–275)	165
<b>mRS after 90 days</b>				
0 (%)	4 (5)		12 (7)	
1 (%)	22 (27)		32 (19)	
2 (%)	17 (21)		42 (26)	
3 (%)	12 (15)		26 (16)	
4 (%)	5 (6)		13 (8)	
5 (%)	1 (1)		3 (2)	
6 (%)	22 (27)		37 (22)	

Time variables are in minutes, median (IQR).

CSC, comprehensive stroke centre; CT, computed tomography; CTA, CT angiogram; DS, drip-and-ship model; ED, emergency department; EMS, emergency medical services; IVT, intravenous thrombolysis; mRS, modified Rankin Scale; MS, mothership model; NA, not applicable; NIHSS, National Institutes of Health Stroke Scale; OTG, time from stroke onset to groin puncture; PSC, primary stroke centre.

The following scenarios were considered for the CSC optimised workflow improvements (DS model): direct transfer from CSC arrival to the angiography suite (maximum of 5 min, scenario 2a); reducing the time from angiography suite arrival to groin puncture to 10 min, based on expert opinion, analysis of the MR CLEAN Registry dataset for all hospitals in the Netherlands, and a previously published study<sup>15</sup> (scenario 2b); and combining the two experiments (scenario 2c). In addition, the PSC and CSC workflow improvements were combined into one experiment (scenario 3).

The scenarios for the MS model were as follows: routing all patients without contraindication for IVT through the ED according to route 2 (CT to CTA to IVT; scenario 4a); reducing time from last examination at the ED to angiography suite arrival to a maximum of 30 min (scenario 4b); and reducing the time from angiography suite arrival to groin puncture to a maximum of 10 min (scenario 4c). Scenarios 4a and 4b are based on expert opinion, analysis of the MR CLEAN Registry dataset on all hospitals in the Netherlands, and a previously published paper.<sup>2</sup> In scenario 4d, all experiments were combined.

## Simulation results

### DS workflow

Implementing all workflow improvements in a PSC (scenario 1d) would imply an absolute increase of 2.2% in the number of patients regaining functional independence after 90 days, a mortality reduction of 1.5%, and a reduction in OTG of 18 min (table 2). Realising workflow improvements within the CSC (scenario 2c) would reduce OTG by 43 min, increase the proportion of patients reaching functional independence at 90 days by 5.3% and reduce mortality by 3.6%. Combining all workflow improvements in both PSC and CSC (scenario 3) would reduce OTG by 61 min, increase the proportion of patients reaching functional independence by 7.4% and decrease mortality by 5.0%.

### MS Workflow

Implementing all workflow improvements (scenario 4d) would reduce OTG by 59 min, increase the number of patients regaining functional independence at 90 days by 3.7% and decrease mortality by 3.0%.

The shifts in likelihood for each mRS score when all workflow improvements are executed in the DS and MS models are displayed in figure 2.

**Table 2** Simulation results

Scenarios	DIDO (DS)	Time from CSC arrival to angiography suite (MS)	OTG	Likelihood of functional independence (95% CI)	Likelihood of mortality (95% CI)
0 (DS)	92.6 (92.4–92.8)	NA	240.7 (240.2–241.1)	52.4 (52.3 - 52.5)	21.4 (21.3 - 21.5)
1a	85.7 (85.5–85.8)	NA	233.8 (233.4–234.1)	53.3 (53.1 - 53.4)	20.8 (20.7 - 20.9)
1b	84.7 (84.6–84.9)	NA	232.8 (232.5–233.2)	53.4 (53.2 - 53.5)	20.7 (20.6 - 20.8)
1c	89.7 (89.6–89.9)	NA	237.8 (237.4–238.2)	52.8 (52.6 - 52.9)	21.2 (21.1 - 21.2)
1d	74.9 (74.8–75.0)	NA	223.0 (222.6–223.4)	54.6 (54.5 - 54.7)	19.9 (19.8 - 19.9)
2a	92.6 (92.4–92.8)	NA	217.4 (217.1–217.7)	55.3 (55.1 - 55.4)	19.4 (19.3 - 19.5)
2b	92.6 (92.4–92.8)	NA	221.0 (220.6–221.4)	54.8 (54.7 - 55.0)	19.7 (19.6 - 19.8)
2c	92.6 (92.4–92.8)	NA	197.7 (197.4–198.0)	57.7 (57.6 - 57.8)	17.8 (17.7 - 17.9)
3	74.9 (74.8–75.0)	NA	180.0 (179.7–180.3)	59.8 (59.7 - 59.9)	16.4 (16.3 - 16.5)
0 (MS)	NA	96.9 (96.7–97.2)	214.5 (214.1–215.0)	49.2 (49.1 - 49.4)	27.7 (27.6 - 27.8)
4a	NA	95.0 (94.9–95.3)	212.7 (212.3–213.1)	49.4 (49.2 - 49.5)	27.6 (27.5 - 27.7)
4b	NA	60.7 (60.6–60.9)	178.4 (178.0–178.7)	51.5 (51.4 - 51.6)	25.8 (25.7 - 25.9)
4c	NA	96.9 (96.7–97.2)	194.1 (193.7–194.6)	50.5 (50.4v50.7)	26.7 (26.6 - 26.8)
4d	NA	58.9 (58.8–60.0)	156.1 (155.7–156.5)	52.9 (52.8 - 53.0)	24.7 (24.6 - 24.8)

Time variables are in minutes, mean (95% CI). Likelihood of functional independence and mortality are in percentages (95% CI).

Scenario 0: baseline model, DS or MS model.

Scenario 1: PSC workflow improvements for DS patients; 1a, all patients are routed according to ED route 2 (CT, CTA, IVT); 1b, prealert to EMS, EMS response time 0 min; 1c, EMS handover time reduced to 11 min; 1d, 1a+1b+1c.

Scenario 2: CSC workflow improvements for DS patients; 2a, expedite CSC door to angiography suite by 5 min; 2b, expedite angiography suite to groin by 10 min, SA1; 2c, 2a+2b.

Scenario 3: total workflow improvements DS patients; 3, 1d+2c.

Scenario 4: total workflow improvement MS patients; 4a, all patients are routed according to ED route 2 (CT, CTA, IVT); 3b, expedite time from last examination ED (IVT/CTA) to angiography suite by 30 min; 3c, expedite angiography suite to groin by 10 min; 3d, 3a+3b+3c.

CSC, comprehensive stroke centre; CT, computed tomography; CTA, CT angiogram; DIDO, door-in-door-out; DS, drip-and-ship model; ED, emergency department; EMS, emergency medical services; IVT, intravenous thrombolysis; MS, mothership model; NA, not applicable; OTG, time from stroke onset to groin puncture; PSC, primary stroke centre; SA, sensitivity analysis.

## DISCUSSION

The results of this study demonstrate that simulation modelling can be used to identify barriers for timely EVT and to assess the impact of workflow improvements in regional acute stroke care systems. Workflow improvements (eg, ED routing of CT to CTA to IVT, prealerting the ambulance, reducing handover time between PSC and EMS, and reducing CSC workflow from hospital arrival to groin puncture) could possibly reduce the time to EVT by approximately 1 hour. For DS patients, we estimate that the suggested workflow improvements could reduce OTG by 61 min, ultimately decreasing mortality by 5.0% and increasing the number of patients regaining functional independence at 90 days by 7.4%. The implementation of all hypothetical PSC workflow improvements for DS patients could make it possible to achieve the DIDO target time value of 75 min.<sup>2,15</sup> For MS patients, the proposed interventions could reduce OTG by 59 min, decrease mortality by 3.0% and increase the number of patients regaining functional independence at 90 days by 3.7%.

For the aforementioned improvements, we specifically considered the acute stroke pathway of our region and the potential improvements that we systematically implemented ‘in silico’. Analysis of the MR CLEAN Registry for all hospitals in the Netherlands nevertheless revealed that some hospitals have already attained the level of our proposed improvements, while others have not. This suggests that the implementation of the proposed improvements could result in even greater benefits and that the selection of policies and improvements will depend on regional set-up and characteristics of existing acute stroke care systems.

The findings for the DS model indicate slightly greater improvement than has been reported in previous studies,

while those for the MS model indicate slightly less improvement, with the number of patients regaining functional independence increasing by between 5% and 6% for each hour reduction in OTG.<sup>2,3</sup> Possible explanations for the difference between our region and other regions might have to do with the fact that data in other studies were collected shortly after the introduction of EVT was newly introduced, as well as with region-specific differences (eg, hospital infrastructure). Furthermore, the use of ordinal logistic regression revealed greater fluctuations in estimating the likelihood of mRS in the DS model, as compared with the MS model. Possible explanations include the fact that a separate ordinal logistic regression was performed for each model, the small sample size (ie, n=154 for the DS model and n=80 for the MS model), and the fact that previous studies have not analysed data in separate routing groups (ie, the DS model vs the MS model).<sup>2,3</sup> Another striking result was the higher probability of death and poor functional outcome for MS patients, despite a decrease in OTG. One possible explanation could be that patients with highly complex comorbidity and ischaemic stroke were more likely to be transferred directly to the CSC instead of to a PSC.

The results of our study can be generalised in part to other regions. Suggested improvements for the acute stroke pathway may be related to a generic conceptual model of care delivery that is consistent with many existing regional pathways and that faces similar challenges. While the impact of these improvements within specific regions will differ, they can jointly create a relevant starting point for optimising stroke systems. The most important benefit of the proposed simulation modelling study is that it allows the testing of potential improvements and the estimation of their impact for specific regions. As suggested by guidelines, and taking regional and patient characteristics into account,<sup>16</sup> simulation modelling may be particularly useful for re-populating the generic model (ie, using conceptual models and patient data from other regions). In addition, simulation modelling might be an attractive option in terms of efficiency, as it starts with hypothetical improvements without immediately requiring investments and costs associated with hardware and organisation. Although it cannot completely replace RCTs, simulation modelling can be useful as a precursor to clinical studies, as a tool for organisational learning, and as a design approach (eg, for acute stroke care).<sup>17,18</sup>

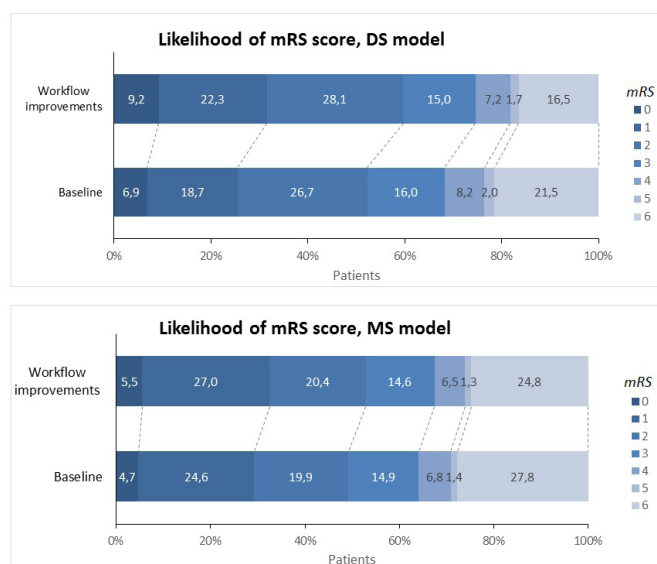

**Figure 2** Shifts in likelihood for each mRS score when all workflow improvements are executed in the DS and MS models. DS, ‘drip and ship’ model; mRS, modified Rankin Scale; MS, ‘mothership’ model.

## Limitations

Our study is subject to several limitations. The simulation model includes only the acute stroke pathway for patients with large vessel occlusion. Ideally, a simulation model should take all suspected patients who had a stroke into account, thereby allowing a more comprehensive assessment of stroke care.

In addition, as a consequence of identifying the optimal ED routing for timely EVT, additional delays for administering IVT were not taken into account. For patients with large vessel occlusion, rapid IVT administration is

associated with less disability at 90 days.<sup>19</sup> Furthermore, many questions remain unanswered with regard to the most beneficial treatment for these occlusion patients: faster IVT and fast EVT; faster EVT with increased delay for IVT; or direct EVT without IVT. Direct EVT is currently being studied in the MR CLEAN NO-IV (ISRCTN80619088)<sup>20</sup> and the SWIFT DIRECT (NCT03192332)<sup>21</sup> trials. The recently published DIRECT-MT study reports that direct EVT was non-inferior compared with IVT and EVT.<sup>22</sup> Until this question is answered, it will be necessary to balance the relative benefits of both treatments.

## CONCLUSIONS

Simulation is useful in assessing the potential effects of reducing region-specific delays from OTG. In our region, potential workflow improvements could reduce the time to treatment by 1 hour, thereby increasing the number of patients regaining functional independence after 90 days by 8% (DS model) and 4% (MS model), in addition to decreasing mortality by 5% (DS model) and 3% (MS model).

### Author affiliations

<sup>1</sup>Department of Neurology, University of Groningen, University Medical Centre Groningen, Groningen, The Netherlands

<sup>2</sup>Health Technology Assessment, Department of Epidemiology, University of Groningen, University Medical Centre Groningen, Groningen, The Netherlands

<sup>3</sup>Department of Radiology, Medical Imaging Centre, University of Groningen, University Medical Centre Groningen, Groningen, The Netherlands

<sup>4</sup>Department of Operations, Faculty of Economics & Business, University of Groningen, Groningen, The Netherlands

**Acknowledgements** We acknowledge the support of the Cardiovascular Research Initiative, part of the Dutch Heart Foundation (CVON2015-01: CONTRAST), the Brain Foundation Netherlands (HA2015.01.06), Health-Holland, Top Sector Life Sciences & Health (LSHM17016), Medtronic and Cerenovus. We also acknowledge the UMCG Emergency Medical Services, Kijlstra Emergency Medical Services and Emergency Medical Services Groningen.

**Contributors** All authors designed the study. WJM, MMHL and MU gathered data. WJM and D-JvdZ analysed the data and made the simulation models. WJM wrote the draft of the manuscript and MMHL, MU, EB and D-JvdZ revised the manuscript for important intellectual content. WJM is the guarantor of this research and accepts full responsibility for the finished work and the conduct of the study, had access to the data and controlled the decision to publish.

**Funding** The CONTRAST consortium is supported by Netherlands Cardiovascular Research Initiative, an initiative of the Dutch Heart Foundation (CVON2015-01: CONTRAST) and by the Brain Foundation Netherlands. It is powered by Health-Holland, Top Sector Life Sciences, and it receives unrestricted funding from Medtronic and Cerenovus. Additional funding for this collaborative project is provided by the Netherlands Ministry of Economic Affairs through a PPP Allowance made available by the Top Sector Life Sciences & Health to stimulate public-private partnerships.

**Competing interests** None declared.

**Patient and public involvement** Patients and/or the public were not involved in the design, or conduct, or reporting, or dissemination plans of this research.

**Patient consent for publication** Not applicable.

**Ethics approval** The MR CLEAN Registry data collection has been approved for the Netherlands by the central medical ethics committee and research board (MEC-2014-235). The need for individual patient consent was waived. A Data Transfer Agreement was drafted and implemented for purposes of linking hospital patient data to the corresponding EMS data.

**Provenance and peer review** Not commissioned; externally peer reviewed.

**Data availability statement** No data are available. The data for this sub-study from the MR CLEAN Registry and the data of the EMS are not publicly available, as they allow for the identification of individual centres. The sharing of such data is in conflict with the privacy regulations in the Netherlands.

**Supplemental material** This content has been supplied by the author(s). It has not been vetted by BMJ Publishing Group Limited (BMJ) and may not have been peer-reviewed. Any opinions or recommendations discussed are solely those of the author(s) and are not endorsed by BMJ. BMJ disclaims all liability and responsibility arising from any reliance placed on the content. Where the content includes any translated material, BMJ does not warrant the accuracy and reliability of the translations (including but not limited to local regulations, clinical guidelines, terminology, drug names and drug dosages), and is not responsible for any error and/or omissions arising from translation and adaptation or otherwise.

**Open access** This is an open access article distributed in accordance with the Creative Commons Attribution Non Commercial (CC BY-NC 4.0) license, which permits others to distribute, remix, adapt, build upon this work non-commercially, and license their derivative works on different terms, provided the original work is properly cited, appropriate credit is given, any changes made indicated, and the use is non-commercial. See: <http://creativecommons.org/licenses/by-nc/4.0/>.

### ORCID iDs

Willemijn J Maas <http://orcid.org/0000-0002-0792-7090>

Maarten M H Lahr <http://orcid.org/0000-0001-7265-2612>

Maarten Uyttenboogaart <http://orcid.org/0000-0002-6934-4456>

Erik Buskens <http://orcid.org/0000-0002-6463-1106>

Durk-Jouke van der Zee <http://orcid.org/0000-0001-9754-1193>

## REFERENCES

- Feigin VL, Nichols E, Alam T, *et al*. Global, regional, and national burden of neurological disorders, 1990–2016: a systematic analysis for the global burden of disease study 2016. *Lancet Neurol* 2019;18:459–80.
- Saver JL, Goyal M, van der Lugt A, *et al*. Time to treatment with endovascular thrombectomy and outcomes from ischemic stroke: a meta-analysis. *JAMA* 2016;316:1279–88.
- Fransen PSS, Berkhemer OA, Lingsma HF, *et al*. Time to reperfusion and treatment effect for acute ischemic stroke: a randomized clinical trial. *JAMA Neurol* 2016;73:190–6.
- Janssen PM, Venema E, Dippel DWJ. Effect of workflow improvements in endovascular stroke treatment. *Stroke* 2019;50:665–74.
- Lahr MMH, van der Zee D-J, Luijckx G-J, *et al*. A simulation-based approach for improving utilization of thrombolysis in acute brain infarction. *Med Care* 2013;51:1101–5.
- Monks T, Pitt M, Stein K, *et al*. Maximizing the population benefit from thrombolysis in acute ischemic stroke: a modeling study of in-hospital delays. *Stroke* 2012;43:2706–11.
- Mr CLEAN-R registry, 2020. Available: <https://www.mrclean-trial.org/> [Accessed 31 Aug 2020].
- Ambulancezorg nederland, 2020. Available: <https://www.ambulancezorg.nl/themas/kwaliteit-van-zorg/protocollen-en-richtlijnen/landelijk-protocol-ambulancezorg> [Accessed 31 Aug 2020].
- Lahr MMH, Luijckx G-J, Vroomen PCAJ, *et al*. Proportion of patients treated with thrombolysis in a centralized versus a decentralized acute stroke care setting. *Stroke* 2012;43:1336–40.
- Paxton P, Curran PJ, Bollen KA, *et al*. Monte Carlo experiments: design and implementation. *Struct Equation Model Multidisciplinary J* 2001;8:287–312.
- Contrast Consortium, 2020. Available: <https://www.contrast-consortium.nl/> [Accessed 31 Aug 2020].
- Plant simulation. Siemens PLM 2019, 2020. Available: <https://www.plm.automation.siemens.com/global/en/industries/> [Accessed 31 Aug 2020].
- Law AM. *ExpertFit version 8 user's guide*. Tuscon, Arizona: Averill M. Law & Associates, 2011.
- Aghaebrahim A, Streib C, Rangaraju S, *et al*. Streamlining door to recanalization processes in endovascular stroke therapy. *J Neurointerv Surg* 2017;9:340–5.
- Ng FC, Low E, Andrew E, *et al*. Deconstruction of interhospital transfer workflow in large vessel occlusion: real-world data in the thrombectomy era. *Stroke* 2017;48:1976–9.
- Turc G, Bhogal P, Fischer U, *et al*. European Stroke Organisation (ESO)- European Society for Minimally Invasive Neurological Therapy (ESMINT) guidelines on mechanical thrombectomy in acute ischemic stroke. *J Neurointerv Surg* 2019;11:535–8.





- 17 Pitt M, Monks T, Crowe S, *et al.* Systems modelling and simulation in health service design, delivery and decision making. *BMJ Qual Saf* 2016;25:38–45.
- 18 Maas WJ, Lahr MMH, Buskens E, *et al.* Pathway design for acute stroke care in the era of endovascular thrombectomy: a critical overview of optimization efforts. *Stroke* 2020;51:3452–60.
- 19 Goyal M, Almekhlafi M, Dippel DW, *et al.* Rapid alteplase administration improves functional outcomes in patients with stroke due to large vessel occlusions. *Stroke* 2019;50:645–51.
- 20 Mr CLEAN-NOIV. Available: <https://mrclean-noiv.nl/> [Accessed 31 Aug 2020].
- 21 Swift direct. Solitaire with the intention for thrombectomy plus intravenous t-PA versus direct solitaire Stent-retriever thrombectomy in acute anterior circulation stroke, 2020. Available: <https://www.swift-direct.ch/> [Accessed 31 Aug 2020].
- 22 Yang P, Zhang Y, Zhang L, *et al.* Endovascular thrombectomy with or without intravenous alteplase in acute stroke. *N Engl J Med* 2020;382:1981–93.

**Supplementary material;** Expediting workflow in the acute stroke pathway for endovascular thrombectomy in the northern Netherlands: A simulation model.

### Introduction

The main text of the manuscript provides the most important findings of the study. This supplementary material provides details of the research setting (Figure S1) and on the simulation modeling methodology and the estimation of each of the 7 scales belonging to the modified Rankin Scale (mRS) score, ranging from 0 (no symptoms) to 6 (death).

### Setting

**Fig. S1.** Regional organization of PSCs and CSCs.

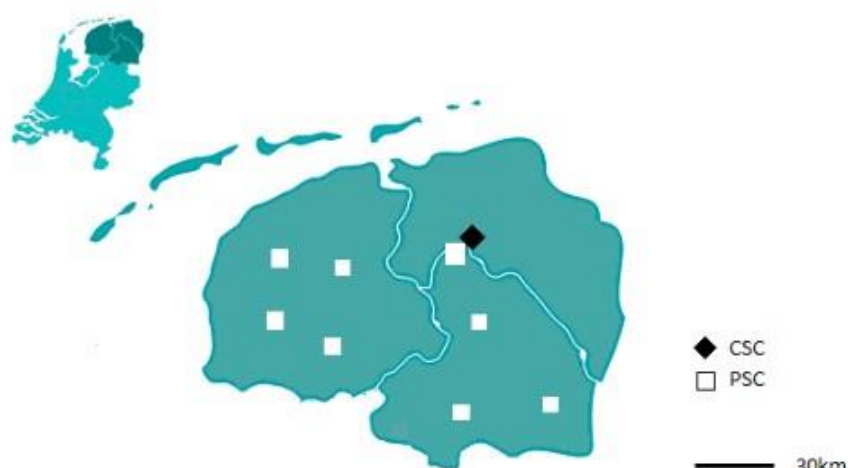

CSC, Comprehensive Stroke Centre; PSC, Primary Stroke Centre

### Simulation modeling methodology

#### *Monte Carlo simulation modeling*

Within the Monte Carlo simulation methodology random variables are used for solving stochastic or deterministic problems. The passage of time plays no substantial role, as there is no competition between

patients.<sup>1</sup> Variety in patient diagnostics, characteristics, time delays towards endovascular thrombectomy (EVT) and routing patterns are incorporated into the model by probability distributions derived from real patient data. The Monte Carlo simulation modeling is to test ‘what if’ scenarios for workflow changes in the acute stroke pathway.

### *Distribution fitting*

Activity durations and diagnostics are modeled by probability distributions, using data on individual patients. ExpertFit™ is used for distribution fitting, supporting the selection of statistical distributions, determining their parameters and testing candidate distributions for their goodness-of-fit.<sup>2</sup> Main steps in distribution fitting concerned:

- Importing of patient data into ExpertFit™.
- Fitting theoretical distributions.
- Seeking further evidence in case goodness of fit tests are indeterminate, in an attempt to underpin the choice of a specific theoretical distribution.<sup>3</sup> Evidence considered includes conceptual usage of the candidate distribution(s), commonalities between highest ranked distributions, and consultation of domain experts. If such evidence is not found an empirical distribution was chosen.

### *Set-up of experiments*

All experiments concern observations on 100.000 hypothetical patients. The number of patients is chosen such that the relative 95% confidence interval half width for the likelihood mRS 0-2 score is below 1%.

### *Software*

Plant Simulation™ was used to model the acute stroke pathway and perform experiments.<sup>4</sup> Expertfit™<sup>2</sup> was used to find the probability distributions and their parameters.

## **Models**

In the main text the conceptual models, the set-up for both the mothership model (MS) and drip-and-ship model (DS), are visualized (figure 2). After stroke onset patients either enter the hospital from outside by

ambulance transportation or are already hospitalized. This applies for both models. 10% of the DS patients were already hospitalized and 12% of the MS patients. After distinguishing these patient routes (Table S1 and Table S2), the following time variable was modeled for hospitalized patients; ‘time from stroke onset to CT’. For patients with a stroke onset outside the hospital the following time variables were modeled; ‘time from stroke onset to 911 call’, i.e. call for help, ‘EMS response’, ‘EMS on scene’, ‘EMS transport’, ‘time from hospital arrival to CT’. The distributions of these time variables are presented in Table S1 (DS model) and Table S2 (MS model).

After the time variables ‘time from stroke onset to CT’ (hospitalized patients) and ‘time from hospital arrival to CT’ (patients outside the hospital) patients are modeled according to the same routes in the emergency department (ED). Within the ED patients are routed according to 3 routes; route 1 = CT to IVT to CTA, route 2 = CT to CTA to IVT and route 3 = CT to CTA (in case of a contraindication for IVT). This applies for both models. For the DS model also the ‘time from last examination ED to transfer call’ is modeled according to these routes. For the DS model the following percentages per routes are used; 37.7% of the patients are routed according to route 1, 41.7% according to route 2 and 20.5 % according to route 3. For the MS model the percentages are; 28.0%, 36.6% and 35.4 %, respectively.

After ED routing the following time variables are modeled in the DS model; EMS response for transfer to a comprehensive stroke center (CSC), EMS handover for transfer, EMS transfer. After CSC arrival there are 2 routes for DS patients; patients with additional diagnostics (10.9%) and patients without additional diagnostics. The following time variables are modeled for patients receiving additional diagnostics; ‘time from hospital arrival to last additional diagnostics’ and ‘time from additional diagnostics to angiography suite’. For the other patients, without additional diagnostics, ‘time from hospital arrival to angiography suite’ is modeled. For all patients the same ‘time from angiography suite to groin puncture’ is modeled. For all distributions of the DS model see Table S1.

For the MS patients the following time variables are modeled after the different routes in the ED; ‘time from last examination ED to angiography suite’ and ‘time from angiography suite to groin puncture’. For all distributions of the MS model see Table S2.

In addition, patients age and diagnostics (National Institutes of Health Stroke Scale (NIHSS) and collaterals) are modeled to estimate the 7 scales of the mRS at 90 days. Collaterals are divided in 4 categories:

absent of collaterals, less than 50% filling of occluded area, more than 50% filling but less than 100% filling of occluded area or 100% filling of occluded area, and NIHSS score and age are both continuous variables. Mean (SD) in the DS model are for NIHSS 15.3 (5.3) and for age 70.2 (12.9) years. Collateral categories were divided in 7.2%, 52.9%, 31.4% and 8.5%, respectively. For the MS model the mean (SD) is 14.9 (5.5) for NIHSS and 65.2 (14.5) years for age. Collateral categories were divided in 10.1%, 35.4%, 36.7% and 17.7%, respectively.

Table S1. Distributions of the DS simulation model.

Activity duration	Distribution	Parameters		
Hospitalized vs. patients outside hospital	Discrete empirical	Value	Frequency	
		Hospitalized	15	
		Outside hospital	150	
Time from stroke onset to CT (hospitalized patients)	Continuous empirical	Lower Bound	Upper Bound	Frequency
		0	30	7
		30	60	5
		227	227	1
Time from stroke onset to 911 call (patients outside hospital)	Continuous empirical	Lower Bound	Upper Bound	Frequency
		0	1	26
		1	5	22
		5	10	17
		10	15	10
		15	20	10
		20	30	11
		30	40	8
		40	50	7
		50	75	10
		75	100	6
100	150	6		
150	200	3		
EMS Response	Beta	Lower endpoint = 2.29; Upper endpoint = 30.53; $\alpha_1 = 2.56$ ; $\alpha_2 = 7.15$		
EMS on Scene	Gamma	Location = 1.70; $\alpha = 5.43$ ; $\beta = 2.73$		
EMS Transport	Weibull	Location = 0.00 $\alpha = 2.11$ ; $\beta = 13.14$		
Time from hospital arrival to CT	Continuous empirical	Lower Bound	Upper Bound	Frequency
		0	5	8
		5	10	21
		10	15	39
		15	20	28
		20	25	14
		25	35	12
		35	55	3
ED routing (3Categories)	Discrete empirical	Value	Frequency	

		Route 1: CT to IVT to CTA	57	
		Route 2: CT to CTA to IVT	63	
		Route 3: CT to CTA	31	
Time from CT to IVT (route 1)	Erlang	Location = 0.00; $\alpha = 1$ ; $\beta = 13.70$		
Time from IVT to CTA (route 1)	Erlang	Location = 0.85; $\alpha = 1$ ; $\beta = 13.69$		
Time from last examination ED to transfer call (route 1)	Gamma	Location = 0.00; $\alpha = 2.63$ ; $\beta = 13.66$		
Time from CT to CTA (route 2)	Gamma	Location = 0.00; $\alpha = 2.63$ ; $\beta = 3.53$		
Time from CTA to IVT (route 2)	Erlang	Location = 0.00; $\alpha = 1$ ; $\beta = 12.57$		
Time from last examination ED to transfer call (route 2)	Continuous empirical	Lower Bound	Upper Bound	Frequency
		0	5	12
		5	15	10
		15	25	14
		25	35	13
		35	60	9
		60	90	3
Time from CT to CTA (route 3)	Lognormal	$\mu = 23.06$ ; $\sigma = 21.72$		
Time from last examination ED to transfer call (route 3)	Continuous empirical	Lower Bound	Upper Bound	Frequency
		0	15	6
		15	30	5
		30	45	8
		45	60	9
		60	95	3
EMS response for transfer	Continuous empirical	Lower Bound	Upper Bound	Frequency
		0	2	12
		2	4	17
		4	6	18
		6	8	29
		8	10	39
		10	15	17
		15	30	8
EMS handover for transfer	Continuous empirical	Lower Bound	Upper Bound	Frequency
		0	5	5
		5	10	31
		10	15	59
		15	20	31
		20	30	11
		30	40	2
EMS transfer	Beta	Lower endpoint = 0.00; Upper endpoint = 50.06; $\alpha_1 = 2.17$ ; $\alpha_2 = 2.29$		
Additional diagnostics vs. no additional diagnostics	Discrete empirical	Value		Frequency
		Additional diagnostics		18

Time from hospital arrival to last additional diagnostics	Gamma	No additional diagnostics Location = 10.39; $\alpha = 1.11$ ; $\beta = 17.41$	147
Time from additional diagnostics to angiography suite	Beta	Lower endpoint = 4.82; Upper endpoint = 124.31; $\alpha_1 = 0.67$ ; $\alpha_2 = 1.60$	
Time from hospital arrival to angiography suite	Gamma	Location = 4.25; $\alpha = 2.23$ ; $\beta = 10.19$	
Time from angiography suite to groin puncture	Beta	Lower endpoint = 4.72; Upper endpoint = 65.69; $\alpha_1 = 4.55$ ; $\alpha_2 = 6.55$	
NIHSS(continuous)	Discrete empirical	Value	Frequency
		3	1
		4	5
		5	3
		6	3
		7	10
		8	7
		9	3
		10	2
		11	2
		12	7
		13	5
		14	10
		15	12
		16	10
		17	19
		18	17
		19	14
		20	9
		21	8
		22	7
		23	6
		24	3
		28	1
Age(Continuous)	Discrete empirical	Value	Frequency
		25	1
		34	1
		38	1
		40	1
		42	1
		45	2
		46	1
		48	1
		51	2
		52	2
		53	3
		54	2
		55	4
		56	1
		57	3
		58	2
		59	4
		60	4
		61	4

62	4		
63	3		
64	4		
65	6		
66	5		
67	5		
68	5		
69	4		
70	5		
71	4		
72	5		
73	7		
74	5		
75	3		
76	2		
77	6		
78	5		
79	6		
80	5		
82	3		
83	7		
84	2		
85	4		
86	7		
87	1		
88	2		
89	2		
90	3		
91	1		
92	1		
93	1		
97	1		
99	1		
Collaterals(2Categories), NIHSS ≤ 15*	Discrete empirical	Value	Frequency
		Absent (0)	11
		less than 50 % filling (1)	81
		> 50% or < 100% filling (2)	48
		100% filling (3)	13

DS, 'drip-and-ship' model; CT, Computed Tomography; EMS, Emergency Medical Services; SD, Standard deviation; IVT, intravenous thrombolysis; CTA, Computed Tomography angiography; ED, Emergency department; NIHSS, National Institutes of Health Stroke Scale.

Table S2. Distributions of the MS simulation model.

Activity duration	Distribution	Parameters		Frequency
Hospitalized vs. patients outside hospital	Discrete empirical	Value		
		Hospitalized		10
Time from stroke onset in hospital to CT (hospitalized patients)	Continuous empirical	Outside hospital		73
		Lower Bound	Upper Bound	Frequency
		0	20	3
		20	90	4
		90	130	2



Time from stroke onset to 911 call (patients outside hospital)	Continuous empirical	Lower Bound	Upper Bound	Frequency
		0	1	10
		1	5	6
		5	10	9
		10	20	10
		20	30	5
		30	50	7
		50	100	11
		100	240	8
EMS Response	Lognormal	$\mu = 9.77; \sigma = 3.61$		
EMS on Scene	Lognormal	$\mu = 21.55; \sigma = 8.16$		
EMS Transport	Weibull	Location = 0.00; $\alpha = 2.16; \beta = 20.03$		
Time from hospital arrival to CT	Log-logistic	Location = 6.47; $\alpha = 6.29; \beta = 2.57$		
ED routing (3Categories)	Discrete empirical	Value		Frequency
		Route 1: CT to IVT to CTA		23
		Route 2: CT to CTA to IVT		30
		Route 3: CT to CTA		29
Time from CT to IVT (route 1)	Log-logistic	Location = 1.79; $\alpha = 8.58; \beta = 2.86$		
Time from IVT to CTA (route 1)	Lognormal	$\mu = 15.74; \sigma = 17.43$		
Time from CT to CTA (route 2)	Beta	Lower endpoint = 0.47; Upper endpoint = 30.69; $\alpha_1 = 1.96; \alpha_2 = 6.53$		
Time from CTA to IVT (route 2)	Gamma	Location = 0.00; $\alpha = 1.44; \beta = 8.93$		
Time from CT to CTA (route 3)	Lognormal	$\mu = 10.96, \sigma = 11.45$		
Time from last examination ED to angiography suite	Gamma	Location = 0.00; $\alpha = 3.49; \beta = 18.63$		
Time from angiography suite to groin puncture	Log-logistic	Location = 0.00; $\alpha = 28.36; \beta = 4.89$		
NIHSS(continuous)	Discrete empirical	Value		Frequency
		2		1
		3		2
		4		2
		5		2
		6		1
		7		2
		8		3
		9		2
		10		4
		11		5
		12		2
		13		3
		14		3
		15		4
		16		7
		17		9
		18		6
		19		4
		20		12

Age(Continuous)	Discrete empirical	21	2
		22	3
		23	2
		27	1
		19	1
		24	1
		27	1
		36	1
		42	1
		46	2
		48	1
		49	1
		50	1
		51	1
		52	2
		53	1
		54	1
		55	2
		56	3
		57	2
		58	2
59	2		
60	1		
61	2		
62	2		
63	1		
64	3		
65	2		
66	3		
68	1		
69	2		
70	6		
71	6		
72	3		
73	3		
74	1		
77	1		
78	3		
79	4		
82	2		
83	1		
85	1		
87	1		
88	2		
89	1		
91	2		
Collaterals(2Categories), NIHSS $\leq$ 15*	Discrete empirical	Value	Frequency
		Absent (0)	8
		less than 50 % filling (1)	28
		> 50% or < 100% filling (2)	29
		100% filling (3)	14

MS, 'mothership' model; CT, Computed Tomography; EMS, Emergency Medical Services; SD, Standard deviation; IVT, intravenous thrombolysis; CTA, Computed Tomography angiography; ED, Emergency department; NIHSS, National Institutes of Health Stroke Scale.

Table S3. Scenarios DS model and MS model.

	Baseline	Input parameters	Source
DS model			
1. PSC workflow, reduce DIDO times			
a. Route 1 = route 2 to reduce time from PSC arrival to departure to CSC.	85*	Choice of routing through ED	Analyses of patient data, UMCG
b. Reduce ambulance response time to 0 minutes, pre-alert for transfer from PSC to CSC	8*	Response time of ambulance	Sablot et al., 2016 <sup>5</sup>
c. Reduce handover time to 11 minutes	14*	Handover time of patient from PSC to ambulance	Analyses of patient data, UMCG
d. Combine PSC workflow improvements; 1a + 1b + 1c		See scenarios 1a, 1b and 1c	
2. CSC Workflow			
a. Reduce time from CSC arrival to angiography suite to a maximum of 5 minutes	26*	Time from CSC arrival to angiography suite	Expert opinion
b. Reduce time from angiography suite arrival to groin puncture to a maximum of 10 minutes	30*	Time from angiography suite arrival to groin puncture	Expert opinion, analysis of the MR CLEAN Registry (NL), Aghaebrahim et al., 2017 <sup>6</sup>
c. Combine CSC workflow improvement; 2a + 2b		See scenarios 2a and 2b	
3. Combine PSC workflow and CSC workflow; 1d + 2c		See scenarios 1d and 2c	
MS model			
4. CSC workflow			
a. Route 1 = route 2 to reduce time from CSC arrival to angiography suite arrival.	98*	Choice of routing through ED	Analyses of patient data, UMCG
b. Reduce time from last examination at the ED (IVT/CTA) to arrival at angiography suite to a maximum of 30 minutes	58*	Time from last examination at ED (IVT/CTA)	Expert opinion, Analysis of the MR CLEAN Registry (NL), Saver et al., 2016 <sup>7</sup> Mehta et al., 2014 <sup>8</sup>
c. Reduce time from angiography suite arrival to groin puncture to a maximum of 10 minutes	28*	Time from angiography suite arrival to groin puncture	Expert opinion, Analysis of the MR CLEAN Registry (NL), Saver et al., 2016 <sup>7</sup>
d. Combine CSC workflow improvement; 1a + 1b + 1c		See scenarios 1a, 1b and 1c	

\*Median times. DS, drip-and-ship; MS, mothership; PSC, primary stroke center; DIDO, door in door out; ED, emergency department; CSC, comprehensive stroke center; IVT, intravenous thrombolysis; CTA, computed tomography angiography.

### *Estimating patient outcomes*

The efficacy of EVT is time dependent. For the simulation model the likelihood of each of the 7 scales belonging to the modified Rankin Scale (mRS) score, ranging from 0 (no symptoms) to 6 (death) is approximated by a ordinal logistic regression model. Regression models are developed for the DS [1] and MS model [2]:

Regression models account for patient characteristics using the following variables;

- Stroke onset-to-groin puncture time (Total delay in minutes), continuous variable
- Age, continuous variable
- NIHSS score, continuous variable
- Collaterals in 4 categories, with dummy variables for absent of collaterals (yes or no, dummy 0), < 50 filling (yes or no, dummy 1), >50% filling, <100% filling (yes or no, dummy 2), 100% filling (yes or no, dummy 3).

[1] For the DS model the following formulas were used (n=154):

$$\text{Likelihood mRS6} = 1/(1+\exp(6.975-(\text{Collaterals\_dummy\_0} * 0.712)-(\text{Collaterals\_dummy\_1} * 0.455)-(\text{Collaterals\_dummy\_2} * -0.148)-(\text{TotalDelay} * 0.006)-(\text{NIHSS} * 0.165)-(\text{Age} * 0.017))))$$

$$\begin{aligned} \text{Likelihood mRS5} &= (1/(1+\exp(6.841- (\text{Collaterals\_dummy\_0} * 0.712)-(\text{Collaterals\_dummy\_1} * \\ &0.455)-(\text{Collaterals\_dummy\_2} * -0.148)-(\text{TotalDelay} * 0.006)-(\text{NIHSS} * 0.165)-(\text{Age} * 0.017))))- \\ &(1/(1+\exp(6.975- (\text{Collaterals\_dummy\_0} * 0.712)-(\text{Collaterals\_dummy\_1} * 0.455)- \\ &(\text{Collaterals\_dummy\_2} * -0.148)-(\text{TotalDelay} * 0.006)-(\text{NIHSS} * 0.165)-(\text{Age} * 0.017)))))) \end{aligned}$$

$$\text{Likelihood mRS4} = (1/(1+\exp(6.359- (\text{Collaterals\_dummy\_0} * 0.712)-(\text{Collaterals\_dummy\_1} * 0.455)-(\text{Collaterals\_dummy\_2} * -0.148)-(\text{TotalDelay} * 0.006)-(\text{NIHSS} * 0.165)-(\text{Age} * 0.017))))-)$$

$$\frac{1}{(1+\exp(6.841 - (\text{Collaterals\_dummy\_0} * 0.712) - (\text{Collaterals\_dummy\_1} * 0.455) - (\text{Collaterals\_dummy\_2} * -0.148) - (\text{TotalDelay} * 0.006) - (\text{NIHSS} * 0.165) - (\text{Age} * 0.017))))}$$

$$\begin{aligned} \text{Likelihood mRS3} = & \frac{1}{(1+\exp(5.549 - (\text{Collaterals\_dummy\_0} * 0.712) - (\text{Collaterals\_dummy\_1} * 0.455) - (\text{Collaterals\_dummy\_2} * -0.148) - (\text{TotalDelay} * 0.006) - (\text{NIHSS} * 0.165) - (\text{Age} * 0.017))))} - \\ & \frac{1}{(1+\exp(6.359 - (\text{Collaterals\_dummy\_0} * 0.712) - (\text{Collaterals\_dummy\_1} * 0.455) - (\text{Collaterals\_dummy\_2} * -0.148) - (\text{TotalDelay} * 0.006) - (\text{NIHSS} * 0.165) - (\text{Age} * 0.017))))} \end{aligned}$$

$$\begin{aligned} \text{Likelihood mRS2} = & \frac{1}{(1+\exp(4.131 - (\text{Collaterals\_dummy\_0} * 0.712) - (\text{Collaterals\_dummy\_1} * 0.455) - (\text{Collaterals\_dummy\_2} * -0.148) - (\text{TotalDelay} * 0.006) - (\text{NIHSS} * 0.165) - (\text{Age} * 0.017))))} - \\ & \frac{1}{(1+\exp(5.549 - (\text{Collaterals\_dummy\_0} * 0.712) - (\text{Collaterals\_dummy\_1} * 0.455) - (\text{Collaterals\_dummy\_2} * -0.148) - (\text{TotalDelay} * 0.006) - (\text{NIHSS} * 0.165) - (\text{Age} * 0.017))))} \end{aligned}$$

$$\begin{aligned} \text{Likelihood mRS1} = & \frac{1}{(1+\exp(2.366 - (\text{Collaterals\_dummy\_0} * 0.712) - (\text{Collaterals\_dummy\_1} * 0.455) - (\text{Collaterals\_dummy\_2} * -0.148) - (\text{TotalDelay} * 0.006) - (\text{NIHSS} * 0.165) - (\text{Age} * 0.017))))} - \\ & \frac{1}{(1+\exp(4.131 - (\text{Collaterals\_dummy\_0} * 0.712) - (\text{Collaterals\_dummy\_1} * 0.455) - (\text{Collaterals\_dummy\_2} * -0.148) - (\text{TotalDelay} * 0.006) - (\text{NIHSS} * 0.165) - (\text{Age} * 0.017))))} \end{aligned}$$

$$\text{Likelihood mRS0} = 1 - \frac{1}{(1+\exp(2.366 - (\text{Collaterals\_dummy\_0} * 0.712) - (\text{Collaterals\_dummy\_1} * 0.455) - (\text{Collaterals\_dummy\_2} * -0.148) - (\text{TotalDelay} * 0.006) - (\text{NIHSS} * 0.165) - (\text{Age} * 0.017))))}$$

[2] For the MS model the following formula was used (n=80):

$$\text{Likelihood mRS6} = \frac{1}{(1+\exp(3.886 - (\text{Collaterals\_dummy\_0} * 0.853) - (\text{Collaterals\_dummy\_1} * 1.262) - (\text{Collaterals\_dummy\_2} * -0.534) - (\text{TotalDelay} * 0.003) - (\text{NIHSS} * 0.010) - (\text{Age} * 0.025))))}$$

$$\text{Likelihood mRS5} = \frac{1}{(1+\exp(3.808 - (\text{Collaterals\_dummy\_0} * 0.853) - (\text{Collaterals\_dummy\_1} * 1.262) - (\text{Collaterals\_dummy\_2} * -0.534) - (\text{TotalDelay} * 0.003) - (\text{NIHSS} * 0.010) - (\text{Age} * 0.025))))}$$

$$(1/(1+\exp(3.886- \text{Collaterals\_dummy\_0} * 0.853)-(\text{Collaterals\_dummy\_1} * 1.262)-(\text{Collaterals\_dummy\_2} * -0.534)-(\text{TotalDelay} * 0.003)-(\text{NIHSS} * 0.010)-(\text{Age} * 0.025))))$$

$$\text{Likelihood mRS4} = (1/(1+\exp(3.444- (\text{Collaterals\_dummy\_0} * 0.853)-(\text{Collaterals\_dummy\_1} * 1.262)-(\text{Collaterals\_dummy\_2} * -0.534)-(\text{TotalDelay} * 0.003)-(\text{NIHSS} * 0.010)-(\text{Age} * 0.025))))- (1/(1+\exp(3.808- \text{Collaterals\_dummy\_0} * 0.853)-(\text{Collaterals\_dummy\_1} * 1.262)-(\text{Collaterals\_dummy\_2} * -0.534)-(\text{TotalDelay} * 0.003)-(\text{NIHSS} * 0.010)-(\text{Age} * 0.025))))$$

$$\text{Likelihood mRS3} = (1/(1+\exp(2.720- (\text{Collaterals\_dummy\_0} * 0.853)-(\text{Collaterals\_dummy\_1} * 1.262)-(\text{Collaterals\_dummy\_2} * -0.534)-(\text{TotalDelay} * 0.003)-(\text{NIHSS} * 0.010)-(\text{Age} * 0.025))))- (1/(1+\exp(3.444- \text{Collaterals\_dummy\_0} * 0.853)-(\text{Collaterals\_dummy\_1} * 1.262)-(\text{Collaterals\_dummy\_2} * -0.534)-(\text{TotalDelay} * 0.003)-(\text{NIHSS} * 0.010)-(\text{Age} * 0.025))))$$

$$\text{Likelihood mRS2} = (1/(1+\exp(1.722- (\text{Collaterals\_dummy\_0} * 0.853)-(\text{Collaterals\_dummy\_1} * 1.262)-(\text{Collaterals\_dummy\_2} * -0.534)-(\text{TotalDelay} * 0.003)-(\text{NIHSS} * 0.010)-(\text{Age} * 0.025))))- (1/(1+\exp(2.720- (\text{Collaterals\_dummy\_0} * 0.853)-(\text{Collaterals\_dummy\_1} * 1.262)-(\text{Collaterals\_dummy\_2} * -0.534)-(\text{TotalDelay} * 0.003)-(\text{NIHSS} * 0.010)-(\text{Age} * 0.025))))$$

$$\text{Likelihood mRS1} = (1/(1+\exp(-0.588- (\text{Collaterals\_dummy\_0} * 0.853)-(\text{Collaterals\_dummy\_1} * 1.262)-(\text{Collaterals\_dummy\_2} * -0.534)-(\text{TotalDelay} * 0.003)-(\text{NIHSS} * 0.010)-(\text{Age} * 0.025))))- (1/(1+\exp(1.722- (\text{Collaterals\_dummy\_0} * 0.853)-(\text{Collaterals\_dummy\_1} * 1.262)-(\text{Collaterals\_dummy\_2} * -0.534)-(\text{TotalDelay} * 0.003)-(\text{NIHSS} * 0.010)-(\text{Age} * 0.025))))$$

$$\text{Likelihood mRS0} = 1-(1/(1+\exp(-0.588- (\text{Collaterals\_dummy\_0} * 0.853)-(\text{Collaterals\_dummy\_1} * 1.262)-(\text{Collaterals\_dummy\_2} * -0.534)-(\text{TotalDelay} * 0.003)-(\text{NIHSS} * 0.010)-(\text{Age} * 0.025))))$$

## References

1. Law AM. Simulation modeling and analysis. Vol McGrawHill: Boston, 5th edition. McGrawHill: Boston, 5th edition.; 2015.
2. Law AM. ExpertFit version 8 user's guide. Tuscon, Arizona: Averill M. Law & Associates; 2011.
3. Stahl JE, Furie KL, Gleason S, Gazelle GS. Stroke: Effect of implementing an evaluation and treatment protocol compliant with NINDS recommendations. *Radiology*. 2003;228(3):659-668.
4. Plant simulation. siemens PLM 2019. <https://www.plm.automation.siemens.com/global/en/industries/>. Accessed 8/31, 2020.
5. Sablot D, Farouil G, Laverdure A, Arquizan C, Bonafe A. Shortening time to reperfusion after transfer from a primary to a comprehensive stroke center. *Neurol Clin Pract*. 2019;9(5):417-423.
6. Aghaebrahim A, Streib C, Rangaraju S, Kenmuir CL, Giurgiutiu DV, Horev A, Saeed Y, Callaway CW, Guyette FX, Martin-Gill C, et al. Streamlining door to recanalization processes in endovascular stroke therapy. *J Neurointerv Surg*. 2017;9(4):340-345.
7. Saver JL, Goyal M, van der Lugt A, et al. Time to treatment with endovascular thrombectomy and outcomes from ischemic stroke: A meta-analysis. *JAMA*. 2016;316(12):1279-1288.
8. Mehta BP, Leslie-Mazwi TM, Chandra RV, Bell DL, Sun CHJ, Hirsch JA, Rabinov JD, Rost NS, Schwamm LH, Goldstein JN, et al. Reducing door-to-puncture times for intra-arterial stroke therapy: A pilot quality improvement project. *J Am Heart Assoc*. 2014;3(6):e000963.