

University of Groningen

On the specification of structural equation models for ecological systems

Grace, James B.; Anderson, T. Michael; Olf, Han; Scheiner, Samuel M.

Published in:
 Ecological monographs

DOI:
[10.1890/09-0464.1](https://doi.org/10.1890/09-0464.1)

IMPORTANT NOTE: You are advised to consult the publisher's version (publisher's PDF) if you wish to cite from it. Please check the document version below.

Document Version
 Publisher's PDF, also known as Version of record

Publication date:
 2010

[Link to publication in University of Groningen/UMCG research database](#)

Citation for published version (APA):

Grace, J. B., Anderson, T. M., Olf, H., & Scheiner, S. M. (2010). On the specification of structural equation models for ecological systems. *Ecological monographs*, 80(1), 67-87. <https://doi.org/10.1890/09-0464.1>

Copyright

Other than for strictly personal use, it is not permitted to download or to forward/distribute the text or part of it without the consent of the author(s) and/or copyright holder(s), unless the work is under an open content license (like Creative Commons).

The publication may also be distributed here under the terms of Article 25fa of the Dutch Copyright Act, indicated by the "Taverne" license. More information can be found on the University of Groningen website: <https://www.rug.nl/library/open-access/self-archiving-pure/taverne-amendment>.

Take-down policy

If you believe that this document breaches copyright please contact us providing details, and we will remove access to the work immediately and investigate your claim.

Downloaded from the University of Groningen/UMCG research database (Pure): <http://www.rug.nl/research/portal>. For technical reasons the number of authors shown on this cover page is limited to 10 maximum.

Ecological Monographs, 80(1), 2010, pp. 67–87
 © 2010 by the Ecological Society of America

On the specification of structural equation models for ecological systems

JAMES B. GRACE,^{1,4} T. MICHAEL ANDERSON,^{2,5} HAN OLFF,² AND SAMUEL M. SCHEINER³

¹*U.S. Geological Survey, National Wetlands Research Center, 700 Cajundome Boulevard, Lafayette, Louisiana 70506 USA*

²*Community and Conservation Ecology Group, Centre for Ecological and Evolutionary Studies, University of Groningen, P.O. Box 14, 9750 AA Haren, The Netherlands*

³*Division of Environmental Biology, National Science Foundation, Arlington, Virginia 22230 USA*

Abstract. The use of structural equation modeling (SEM) is often motivated by its utility for investigating complex networks of relationships, but also because of its promise as a means of representing theoretical concepts using latent variables. In this paper, we discuss characteristics of ecological theory and some of the challenges for proper specification of the theoretical ideas in structural equation models (SE models). In our presentation, we describe some of the requirements for classical latent variable models in which observed variables (indicators) are interpreted as the effects of underlying causes. We also describe alternative model specifications in which indicators are interpreted as having causal influences on the theoretical concepts. We suggest that this latter nonclassical specification (which involves another variable type—the composite) will often be appropriate for ecological studies because of the multifaceted nature of our theoretical concepts.

In this paper, we employ the use of meta-models to aid the translation of theory into SE models and also to facilitate our ability to relate results back to our theories. We demonstrate our approach by showing how a synthetic theory of grassland biodiversity can be evaluated using SEM and data from a coastal grassland. In this example, the theory focuses on the responses of species richness to abiotic stress and disturbance, both directly and through intervening effects on community biomass. Models examined include both those based on classical forms (where each concept is represented using a single latent variable) and also ones in which the concepts are recognized to be multifaceted and modeled as such. To address the challenge of matching SE models with the conceptual level of our theory, two approaches are illustrated, compositing and aggregation. Both approaches are shown to have merits, with the former being preferable for cases where the multiple facets of a concept have widely differing effects in the system and the latter being preferable where facets act together consistently when influencing other parts of the system. Because ecological theory characteristically deals with concepts that are multifaceted, we expect the methods presented in this paper will be useful for ecologists wishing to use SEM.

Key words: coastal wetland; composite variables; formative measurement; meta-models; multifaceted concepts; reflective measurement; structural equation meta-models; structural equation modeling; theoretical concepts; theoretical constructs.

INTRODUCTION

Ecological research, especially the study of communities and ecosystems, has been accused of lacking sufficient cohesion to support robust generalizations.

Manuscript received 17 March 2009; accepted 20 May 2009.
 Corresponding Editor: A. M. Ellison.

⁴ E-mail: gracej@usgs.gov

⁵ Present address: Wake Forest University, Biology Department, Winston-Salem, North Carolina 27109 USA.

As Lawton (1999) described the problem, "... ecological patterns and the laws, rules and mechanisms that underpin them are contingent on the organisms involved and their environment. This contingency is manageable at a relatively simple level of ecological organization [e.g., populations] and ... in large sets of species [macroecological studies], but overwhelmingly complicated at intermediate scales characteristic of community ecology." Several authors (Simberloff 2004, Scheiner and

Willig 2005, Kearney and Porter 2006, McGill et al. 2006) have challenged Lawton's conclusion and argued that the continued study of communities and ecosystems is not only scientifically valid, but essential to societal needs.

Underlying the discussion of how to study ecological communities is the fundamental problem of extracting generalizations when studying heterogeneous collections of study objects. Communities and ecosystems represent heterogeneous collections compared to many other fields of endeavor (e.g., population ecology) because the units of study vary from one to the next in both species composition and environmental controls. Yet, communities and ecosystems have common properties of general interest just as do other objects of study. The solution to the problem of generalizing about communities and ecosystems, we believe, calls for suitable methods and procedures (Scheiner and Willig 2005).

Recently, ecologists have become attracted to the possibility that *structural equation modeling* (SEM) can be used to address this challenge by providing a way to link specific system attributes to general, theoretical concepts through the use of latent variables. Structural equation modeling (Bollen 1989, Kline 2005) is a scientific methodology that aspires to make a strong and explicit connection between empirical data and theoretical ideas. While SEM has its roots in evolutionary genetics (from path analysis; Wright 1921), most developments have occurred in the human sciences within the disciplines of econometrics, psychometrics, and sociometrics (Tomer 2003). There are a growing number of efforts to adapt SEM to the study of biological problems (Shiple 2000, Pugesek et al. 2003, Grace 2006), including studies of natural selection (Scheiner et al. 2000), life history strategies (Vile et al. 2006), ecological communities (Irwin 2006), genomics (Li et al. 2006), and physiological integration (Tonsor and Scheiner 2007).

Reasons biologists might use SEM include: (1) it is theory oriented, as opposed to null hypothesis oriented, (2) its capacity to represent hypotheses about causal networks, (3) its procedures for testing among competing models, and (4) its value as a framework for interpretation when there are large numbers of predictors and responses with complex causal connections. An important part of the appeal of SEM for ecologists and evolutionary biologists is the claim that it can facilitate our ability to relate data to theory by using latent variables to represent theoretical entities. It is this aspect of SEM that we focus on in this paper. In our presentation we consider conventional structural equation modeling practice and suggest the use of meta-models as aids for translating theoretical ideas into *structural equation models* (SEM models). First, we give a brief synopsis of the structural equation modeling workflow process to facilitate the discussion that follows. Because of the significant amount of terminology required to describe the issues in this paper, we include a glossary (Table 1). When terms in the glossary are first used in the text, they are italicized.

A BRIEF OVERVIEW OF STRUCTURAL EQUATION MODELING

Background

SEM is best understood as a scientific framework, not a particular statistical technique. Here we are distinguishing between statistical tools and how those tools are used for building scientific knowledge from evidence (Scheiner 2004). SEM is concerned with developing and evaluating models so as to extract scientific understanding about systems. Numerous statistical techniques have been employed in SEM analyses. In the first generation of SEM, estimation was conducted through the decomposition of correlations (Wright 1934), while in the second generation, maximum likelihood procedures have predominated. More recently, Bayesian ideas and methods have been incorporated in structural equation models (e.g., Raftery 1993) and estimation using Markov Chain Monte Carlo methods in combination with Bayes' theorem is becoming increasingly common (Scheines et al. 1999, Rupp et al. 2004, Arhonditsis et al. 2006, Lee 2007).

One thing that distinguishes SEM from most other current approaches to data modeling is its emphasis on estimating causal effects through the study of path relations (for example, through the test of *mediation*). Because of its focus on understanding direct and indirect pathways, SEM is well suited for studying hypotheses about multiple processes operating in systems, which is a key reason biologists are becoming increasingly interested in SEM. SEM involves more than simply the estimation of model parameters, however. It also fits within a workflow process designed to advance our scientific understanding (Fig. 1). In this process, theoretical ideas are first translated into models for evaluation (step 1), a process known in statistical circles as *specification*. Formulated models must then be considered for their mathematical suitability (step 2), especially for their identification (whether the structure of the model permits unique estimates for all parameters. Parameter estimates (step 3) permit the creation of a model-implied covariance matrix, which is used to evaluate model-data consistency through *model testing*. If it is determined that alternative models need to be evaluated (step 4), the process can continue (step 5), but we now judge that our application of SEM is exploratory (until additional data are available for testing revised models). Only when we determine that our model is acceptable (step 6), and to the degree possible our best model, do we trust parameter estimates, which feeds into the process of interpretation for our specific situation (step 7). Generalization to some broader population of hypothetical samples or cases can be either formal (e.g., meta-analytic summaries or multigroup comparisons) or informal (abstraction or synthesis, step 8). In the process of generalization, we involve additional information such as scientific context, suspected contingencies, the limits of the data, and our scientific objectives. Finally, the activity of generalization informs the distillation of theoretical models and ideas

TABLE 1. Terminology related to structural equation models and the extensions presented in this paper.

Term	Definition
Aggregation of indicators	A process whereby indicators can be combined so as to represent model components at a higher level of abstraction.
Block	A basic unit of model construction that involves indicators and either latent or composite variables (Fig. 4).
Causal indicators	Sometimes referred to as cause indicators. Observed variables that represent influences on a latent variable. In the case of causal indicators, arrows in an SE model point from indicators to latent variables. Composites are specified using causal indicators.
Composite variables	A special type of latent variable that is completely specified by causal indicators. Composites typically possess no estimate of measurement error; if they did, they would be referred to as latent composites. The differences between composite and latent variables are detailed in Fig. 4.
Construct	Something constructed from the human mind, a concept, or an ideal object. Often refers to a conceptualization that has been thoughtfully considered for its validity (see “validity”).
Effect indicators	Observed variables representing the effects (manifestations) of latent processes. Generally arrows in a structural equation model point from latent variables to effect indicators.
Emergent variable system	A collection of variables with some common properties, but with inconsistent relations to other parts of a system.
Endogenous variables	Variables with single-headed arrows pointing to them in a model.
Exogenous variables	Variables without single-headed arrows pointing to them, but typically with single-headed arrows pointing away from them.
Factor analytic	From factor analysis, in which constructs are modeled using latent variables with multiple effect indicators (Fig. 7A).
Formative measurement	A situation where causal indicators are associated with a latent variable or composite.
Hybrid model	Models that contain both factor-analytic and path elements (Fig. 4). In such models, we refer to the structural model as the relationships among latent variables and the measurement model as the relationship of indicators to latent variables.
Indicators	Observed variables, i.e., ones for which we have measurements.
Latent variables	Hypothesized variables for which we have no direct measurements.
Manifest variables	Measured (observed) variables.
Measurement error	The error associated with obtaining precise (repeatable) values for a variable. When a variable is measured with error, it is often recognized in SEM that there exists a difference between the latent, error-free variable we wished to measure and the observed (error-contaminated) variable actually measured.
Measurement model	The part of a structural equation model that relates the indicator to the latent or composite variables.
Mediation	A key feature of SEM is the test of mediation, which relates directly to the study of causal relationships using path relations. In the test of mediation, we ask whether the effect of one entity (X) on another (Y) can be explained by a third variable (Z).
Model degrees of freedom	In SE models, the model degrees of freedom come from having more known values (from the covariance matrix of the data) than estimated values (required by the model). Models in which all possible pathways are specified are saturated and possess 0 degrees of freedom. Nonzero degrees of freedom permit the testing of model structure.
Model testing	In SEM, model testing is principally directed toward the discovery of misspecification, or the mismatch between model structure and data structure. When models fail to include important pathways, they fail the test of absolute fit. When models contain unimportant pathways, they are said to fail the test of parsimony. A key element of model building and testing in SEM is that the addition or removal of pathways should be based on theoretical justifications rather than as part of an automatic procedure.
Reflective measurement	The situation where effect indicators are associated with a latent variable.
Reliability	The degree to which indicators correlate with the true scores for a latent variable.
Second-order latent variable	A latent variable whose indicators are other latent variables.
Second-order latent composite	A latent variable whose latent indicators are causal/formative and for which error variance is declared to be zero.
Sheaf coefficient	The coefficient summarizing the effect of a <i>composite</i> on some response, usually associated with an outgoing arrow from a composite.
Specification	The process of converting a theory into a statistical model.
Structural equation meta-model (SEMM)	A general-form model that represents processes among theoretical constructs, while omitting statistical details.
Structural equation modeling (SEM)	The process of developing and evaluating structural equation models.
Structural equation models (SE models)	Statistical models containing or specifying multiple, causal pathways. SE models typically specify all of the elements of the underlying equations.
Two-stage compositing process	In the first stage of the development of models with composites, a partially reduced form of the model is used for evaluating the significance of pathways contributing to the composite. In the second stage, the combined effects of causal indicators are summarized through the development of composites and the estimation of a sheaf coefficient. See Grace and Bollen (2008) for details.
Validity	The degree to which indicators accurately represent the theoretical meaning of a construct.

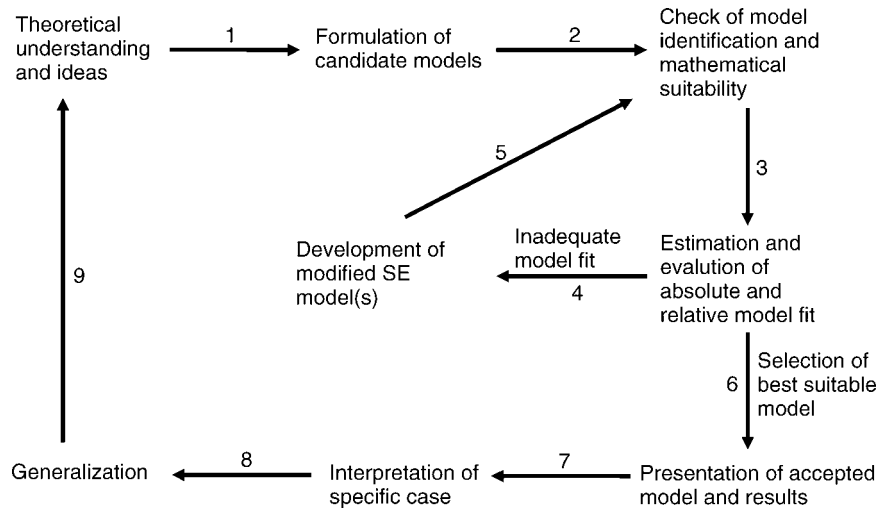

FIG. 1. The workflow process associated with structural equation modeling (SEM). The SEM process is based on principles of sequential learning and repeated testing of ideas and interpretations. Structural equation meta-models primarily aid step 1, though they may also support steps 8 and 9.

(step 9), which then guides the specification of new candidate models for subsequent study (step 1).

An illustration of the modeling process

Keeley et al. (2005) conducted a study of the postfire response of California shrubland (chaparral and sagebrush) communities that was further investigated by Grace and Keeley (2006) using SEM. Here we use a subset of the data from that study for illustrative purposes (Fig. 2). (In figures and tables throughout the paper, theoretical constructs and latent variables have initial capitalization and observed variables are uncapitalized.) Keeley et al. (2005) sought to understand

spatial heterogeneity in postfire vegetation recovery following extensive wildfires that occurred in southern California in 1993. Ninety study sites were established across the burned region and 1000-m² plots (one at each site) were used to sample prefire conditions and postfire responses. In this example, we consider three variables: the maximum age of shrub stands that burned in the fire (estimated from growth rings of remaining stem bases), fire severity (based on postfire skeletal remains), and plant cover in the year following the burn (measured as percentage of ground surface).

Prior to multivariate examination of the data, hypotheses were developed for evaluation using SEM.

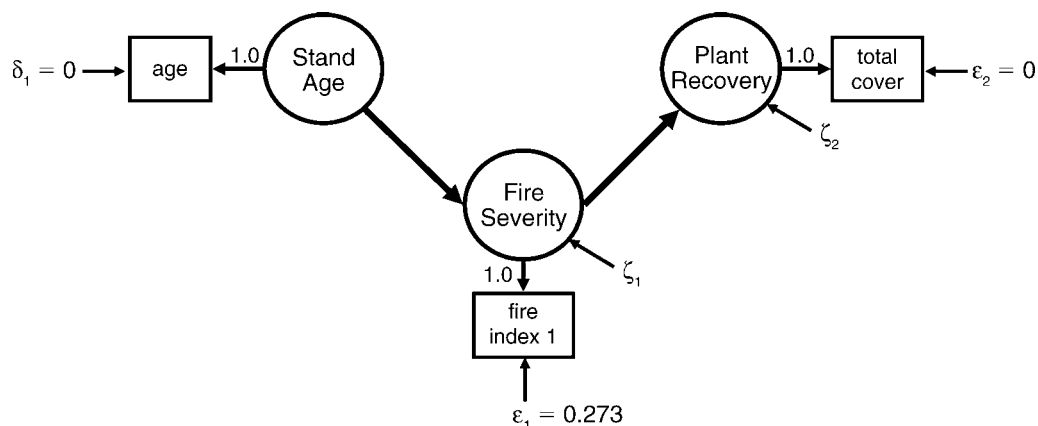

FIG. 2. Example model used to illustrate the structural equation modeling process, extracted from a larger model presented by Grace and Keeley (2006). This model evaluates the hypothesis that the reason older stands of shrubs have lower rates of post-fire plant recovery is because they have more severe fires. Circles represent latent variables; boxes represent observed variables that serve as indicators for the latent variables. In figures and tables throughout, theoretical constructs and latent variables have initial capitalization, and observed variables are uncapitalized. A fixed quantity of error variance (0.273) is specified for the measure of fire severity while the error variances for age and total cover are set to 0; δ_1 is the error term for exogenous variable 1, and ϵ_1 and ϵ_2 are the error terms for endogenous variables 1 and 2. See *A brief overview of structural equation modeling: An illustration of the modeling process* for an explanation of the variables.

In this example, older shrub stands had lower plant recovery after fire. The first and primary mechanism hypothesized was that older stands would have possessed more fuel and thereby experienced more severe fires. The more severe fires in older stands would presumably cause more damage to perennial tissues and higher mortality of seeds in the soil seedbanks (Keeley 1991), leading to reduced plant recovery. Since there were estimates of fire severity at each site, it is possible to perform the test of *mediation*. If the relationship between plant recovery and stand age was caused by higher fire severity in older stands, covariances among variables should be consistent with the model in Fig. 2. This model implies a mathematical equivalency between the covariance between stand age and plant recovery and the product of the coefficients for the two paths linking stand age to plant recover (stand age affects fire severity and fire severity affects plant recovery). A failure to observe that equivalency (known as conditional independence) implies some other process mediating the observed relationship between stand age and plant recovery. The authors considered several candidate mechanisms, including: (1) older stands had depleted seed banks (because of seed mortality over time) and (2) in older stands shrubs resprouted more vigorously and those resprouts suppressed the establishment of herbaceous plants.

We can deepen our consideration of SEM in this example through the use of *latent variables* with single *indicators* (Fig. 2). Fundamental to modern SEM practice, it is recognized that *measurement error* contributes to bias in path coefficients. In this case, the researchers had previously conducted studies in which the repeatability of fire severity measurements was evaluated. Based on this information (and methods described in Grace and Keeley 2006), *measurement reliability* was used to specify the error for fire index 1 in the model.

We estimated the model with data from Grace and Keeley (2006) using maximum likelihood procedures in conjunction with the software Mplus (version 4.21; Muthén and Muthén 2008), which provides us with a chi-square statistic that can be used to test the hypothesis of model – data consistency. In this case, we obtain a chi-square (χ^2) of 2.35 with 1 *model degree of freedom*, which has an associated *P* value for goodness of fit equal to 0.125. Using the standard critical *P* value of 0.05 (below which we would declare a significant deviation between observed and model-implied covariances), we conclude that the model is a sufficient approximation of the true model that we can use the parameter estimates obtained for interpretation. Further evaluations of the model showed that no pathway could be dropped from the model without resulting in significant deviations between model and data. Because this example is included simply to illustrate certain steps in the SEM process, model results are not presented or discussed here (see Grace and Keeley 2006 for more detail).

Relative to the SEM process outlined in Fig. 1, in this example theoretical ideas were used to consider possible models in advance of the estimation process. The initial model was found to be adequate and further evaluations showed it to be robust. The SEM workflow process encourages and supports the conduct of subsequent studies and Keeley et al. (2008) have further examined relationships between stand age, fire severity, and plant recovery. Building on the initial results from Grace and Keeley (2006), Keeley et al. (2008) used data from another set of fires in chaparral habitat to examine more complex structural equation models that evaluated the roles of stand age, stand architecture, and abiotic conditions on fire severity and plant recovery. In that study, they found an effect of stand age on plant recovery independent of fire severity (i.e., a direct path from stand age to plant recovery; Fig. 2). Collectively, these results suggest that our theoretical model of fire in these ecological systems should allow for additional processes whereby stand age can influence post-fire plant recovery. SEM philosophy also encourages subsequent studies to investigate the causes behind direct paths by measuring presumed linking factors and performing tests of mediation, thereby strengthening our understanding of causal mechanisms.

Latent variables and theoretical constructs

Ecologists have a significant history of using path models (e.g., Wootton 2002), though not with the inclusion of latent variables. Such models are sometimes referred to as econometric models (Bollen 1989:80) and are of the form

$$\mathbf{y} = \mathbf{\Gamma}\mathbf{x} + \mathbf{B}\mathbf{y} + \boldsymbol{\zeta} \quad (1)$$

where \mathbf{y} is a vector of *endogenous* response variables, \mathbf{x} a vector of *exogenous* predictors, $\mathbf{\Gamma}$ and \mathbf{B} are matrices of coefficients, and $\boldsymbol{\zeta}$ is a vector of errors for the equations. The classic form of structural equation models is described by the three fundamental equations of the LISREL model (Bollen 1989:319–320):

$$\mathbf{x} = \mathbf{\Lambda}_x\boldsymbol{\xi} + \boldsymbol{\delta} \quad (2)$$

$$\mathbf{y} = \mathbf{\Lambda}_y\boldsymbol{\eta} + \boldsymbol{\varepsilon} \quad (3)$$

$$\boldsymbol{\eta} = \mathbf{B}\boldsymbol{\eta} + \mathbf{\Gamma}\boldsymbol{\xi} + \boldsymbol{\zeta}. \quad (4)$$

Here \mathbf{x} and \mathbf{y} are interpreted as vectors of observed indicators of exogenous and endogenous latent variables, $\boldsymbol{\xi}$ and $\boldsymbol{\eta}$ are vectors containing the individual exogenous and endogenous latent variables, $\mathbf{\Lambda}_x$ and $\mathbf{\Lambda}_y$ are vectors of coefficients relating indicators to latent variables, \mathbf{B} and $\mathbf{\Gamma}$ are now coefficient matrices for effects of endogenous and exogenous latent variables on endogenous latent variables, $\boldsymbol{\delta}$ and $\boldsymbol{\varepsilon}$ are vectors of measurement errors for \mathbf{x} and \mathbf{y} , and $\boldsymbol{\zeta}$ is a vector of errors for the $\boldsymbol{\eta}$ variables. Essentially, the LISREL

equations describe a framework in which causes are seen to be latent and the observed variables are manifestations of latent processes.

The interpretation of a latent variable is one for which we have no observed values or “sample realizations” (Bollen 2002). However, frequently much more is implied by the term. A historical perspective can yield some insight into the various ways latent variables are discussed. The latent variable tradition in SEM stems from early work by Spearman (1904) who proposed a one-factor model of general intelligence for humans. Spearman proposed that what was of interest was an underlying ability that could only be measured indirectly, with empirical measures of intelligence presumed to be imperfect representations of the underlying causal mechanisms. Sewell Wright, the originator of path analysis and an evolutionary biologist, also used latent variable models (Wright 1918) to examine hypotheses about the genetic control of animal allometry. Following from such work, the *factor-analytic* perspective arose and has long held a central place within the SEM tradition.

In contemporary SEM, latent variables are frequently relied upon to represent theoretical *constructs* in models (although there are actually several uses of latent variables in models, see Bollen 2002). One of the leading introductory textbooks on SEM (Kline 2005) describes latent variables as allowing for the testing of hypotheses “... at a higher level of abstraction” and goes on to state that latent variables serve as a means of representing “theoretical constructs”. Raykov and Marcoulides (2006) give that through the use of latent variables, SE models are “... conceived in terms of not directly measurable ... theoretical or hypothetical constructs.” Other authors (MacCallum 1995, Schumacker and Lomax 1996) provide similar descriptions. Because the use of latent variables and associated concepts are not a traditional part of biometric training, it is important that ecologists and other natural scientists have additional background information before using latent variables in SE models.

To fully understand the above statements, we need to be clear about what is meant and implied by the use of the term “construct.” Viswanathan (2005) defines a construct as “... a concept specifically designed for scientific study.” He goes on to say, “Constructs are concepts devised or built to meet scientific specifications. These specifications include precisely defining the construct, elaborating on what it means, and relating it to existing research.” Thus, the nuanced difference between a concept and a construct is that the latter has been rigorously defined for scientific purposes and its treatment as a coherent entity with consistent properties can be justified. There are many concepts in ecology that meet these criteria; however, because of the absence of an equivalent measurement tradition in the biological sciences, there has been no formal consideration of these distinctions.

When it comes to the details of specifying structural equation models using latent variables, there has been a substantial debate about a variety of issues in the human sciences. As we discuss below, classical measurement theory (Nunnally and Bernstein 1994: Chapter 6) presumes that underlying constructs (or at least their dimensions) can be represented using latent variables and the measured indicators are to be viewed as effects (or reflections) of the underlying latent causes. There are cases, however, where the measured indicators actually have causal influences on the construct (e.g., they form the construct). Here, proper model specification can be quite different from that defined by classical measurement theory. When the wrong specification is used for a situation, the misspecification can have profound effects on model results and the validity of interpretations. A number of studies have discussed this issue and shown the need to routinely consider formative measurement options in model specification (Bagozzi and Edwards 1998, Diamantopoulos and Winklhofer 2001, Edwards 2001, Jarvis et al. 2003, MacKenzie et al. 2005, Bagozzi 2007, Bollen 2007, Diamantopoulos et al. 2008). These studies further suggest that SE models may be commonly misspecified because of the tendency to assume that a classical (reflective) approach is the appropriate way to proceed. The characteristics of the theoretical concepts being modeled have a major influence on the proper way to specify models related to those concepts. For this reason, in the next section we will briefly consider some of the distinctive characteristics of theoretical concepts in ecology.

THE NATURE OF THEORETICAL CONCEPTS IN COMMUNITY AND ECOSYSTEM ECOLOGY

The question of what constitutes a coherent theory in ecology has received significant consideration (e.g., Pickett et al. 2007). Both Bollen (2002) from the social sciences and Scheiner and Willig (2005) from the ecological sciences offer similar descriptions of scientific theories. In the words of Scheiner and Willig (2005), “A unified theory is a conceptual structure consisting of a few general propositions that characterize a wide domain of phenomena and from which can be derived an array of models.” Theories typically deal with specified objects of study, their properties, and the processes that cause relationships. In the social sciences, the objects of study are typically individual human beings or some level of their aggregation. There is a strong parallel to population ecology here, with its focus on a single species, its attributes, and behaviors. For the study of ecological communities or ecosystems, which include all the species and their abiotic conditions within a defined area, the objects of study are characteristically more diverse in the sense that they differ from each other to a greater degree than in studies of a single species. To use an analogy, in community and ecosystem ecology it can be said that we seek to compare apples with oranges, while in population ecology, we seek to compare apples

with apples. In both cases, there is a degree of heterogeneity that is ignored for the sake of generalization. In the study of populations, the genetic, phenotypic, and historical differences among individuals are often ignored for the sake of model simplicity and generality. In the study of communities, the objects of generalization characteristically differ from each other to a greater degree. In both cases, however, objects have common properties and theories are based on propositions about the mechanistic causes of the relationships among those objects.

One thing that challenges the study of communities and ecosystems is the degree of abstraction sometimes associated with its theoretical concepts. Some concepts are quite concrete, others less so. While we can readily count the number of species in a community sample (though with less than perfect reliability), often theoretical interest focuses on a more general idea like biodiversity, which encompasses not only the number of species but other properties such as the variety of functional groups, taxonomic lineages, and the equitability of representation among members of the group. Other theoretical concepts often discussed in ecology include entities such as trophic levels, resources, environmental stress, disturbance, productivity, stability, and resilience. In the social sciences, multifaceted concepts such as these are sometimes referred to as *emergent variable systems* (DeVellis 2003, Kline 2006).

A further challenge to comparison and generalization in ecology is that the metrics used to measure theoretical constructs in different communities are not entirely consistent. The inconsistency is driven, in part, by the need to sample what is appropriate for each community or ecosystem. Grassland communities, for example, typically differ in species composition and life form distributions. Even greater differences exist, for example, when comparing grassland and shrubland communities. Such differences can have substantial implications for our ability to compare these communities since metrics are contingent on the non-overlapping elements in the different samples. For example, functional groups are defined by their constituent species, so that the diversity of functional groups is dependent on the species in each community. Contingency may be even greater for the abiotic features that are important in different locations.

To be more explicit, we might represent the effects of environmental stress on community properties (for example) as

$$\mathbf{Y} \leftarrow \Theta \mathbf{X} + \zeta \quad (5)$$

where \mathbf{Y} is a set of community properties, \mathbf{X} is a set of abiotic properties (e.g., soil properties for terrestrial ecosystems or water quality properties for aquatic ecosystems), Θ is a matrix of coefficients, and ζ is a set of unspecified factors influencing \mathbf{Y} . We use the directional arrow instead of an equality sign in deference to Pearl's (2000) complaint about the causal ambiguity

of the mathematical equality sign. When \mathbf{Y} is represented by a common metric y and \mathbf{X} a common metric x across all objects in a sample, we can describe an element of Θ (b) that relates the per unit effect of x on y . The statistical properties of this situation are well understood. However, what do we do when we wish to compare a case where the influential elements of \mathbf{Y} are x_1 , x_2 , and x_3 , to another case where the influential elements of \mathbf{Y} are x_4 , x_5 , and x_6 ? Such a comparison is a central challenge for the study of ecological systems (Lawton 1999). The typical solution has been for theories to be evaluated informally and verbally rather than rigorously and quantitatively.

USING META-MODELS TO GUIDE SPECIFICATION OF STRUCTURAL EQUATION MODELS

Meta-modeling is the process of establishing a general framework for designing specific models. Meta-models, in turn, are ones that serve the purpose of defining general model features that can apply to a variety of particular situations. Meta-modeling has been proposed as a fundamental methodological necessity for dealing with complex systems (Van Gigh 1991), though it has seen limited usage as a formal process outside of computer programming up to this point. We define *structural equation meta-models* (SEMMs) as models that represent general relationships among multiple theoretical constructs while omitting statistical detail. In essence, many conceptual models can be seen to serve as meta-models, but with meta-modeling there is intended a greater degree of formality. We argue in this paper that meta-models can (1) help to organize ecological theory in a form that is more clearly defined and operational, (2) facilitate the proper specification of structural equation models, (3) provide a framework for drawing general interpretations from our analyses, and (4) aid in making comparisons. In this section, we first demonstrate the translation of a set of theoretical propositions into a meta-model, and then give some of the criteria that should be considered when deciding on appropriate ways to specify SE models, and finally present an application.

A structural equation meta-model

In 1999, Grace proposed a synthetic theory of diversity regulation for grassland ecosystems. This theory can be described in terms of the theoretical definitions of the constructs (including any separate dimensions) and a set of propositions about the processes that connect constructs. In this case, we have four constructs to define, all of which have been discussed at length in the ecological literature. First, we define abiotic stress as the environmental conditions in a system that collectively limit biological productivity below the potential physiological maximum of the species mixture. At a general level, there are two major dimensions associated with this definition, the edaphic and the climatic. Individual elements may combine to

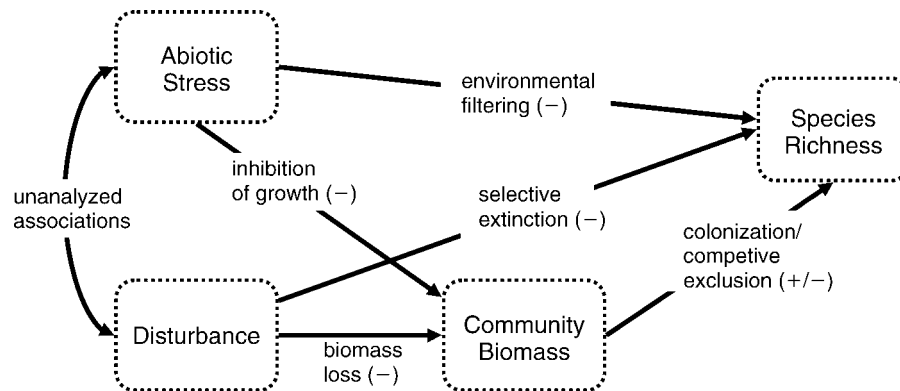

FIG. 3. Initial structural equation meta-model representing major categories of influences on spatial variations in plant diversity. For theoretical background, see Grace (1999). Round-edge boxes with dotted outlines represent theoretical constructs. The meaning of the labels assigned to pathways is described in *Using meta-models to guide specification of structural equation models: A structural equation meta-model*, along with the theoretical definitions of the constructs.

cause abiotic stress, although a single element can dominate. Second, a “disturbance” is an event that causes abrupt damage or mortality resulting in a loss of community biomass. There are numerous agents that can cause disturbance, including fires, human activities, grazing, storms, floods, and landslides. What all these agents have in common is damage and mortality. However, for each type of agent there can be unique impacts not shared by the other types (e.g., grazers and some human activities disturb the soil, while others, such as fire and storms, typically do not). Numerous theoretical analyses have considered the potential effects of disturbance on ecological communities. Third, community biomass represents organic matter accumulated through the generative actions of organisms. Related constructs include: gross production, the rate of loss or turnover of material, the rate of accumulation of material, and the accumulation of dead organic matter. There can also be dimensions to biomass, including above- vs. belowground biomass and stems vs. leaves. Finally, plant diversity refers to the variety of organism in a place. It has three major dimensions, (1) the number of species, (2) the degree of inequality of their representations, and (3) the variety of functional attributes they collectively contain.

Propositions about processes that connect constructs include the following: (1) Disturbance results in a reduction of community biomass through a direct loss of material. (2) Disturbance can result in a loss of species through selective extinction. (3) Abiotic stress inhibits growth, which may lead to local reductions in community biomass. (4) Abiotic stress affects species richness through a filtering of the species pool whereby fewer and fewer species can survive at increasing levels of stress. (5) Community biomass and species richness respond uniquely to abiotic stress because surviving species (e.g., saltmarsh species) may actually be quite productive. (6) Species richness initially increases with increas-

ing community biomass but begins to decline at higher levels because of competitive exclusion.

The above-described theoretical constructs and causal processes involved in the synthetic theory of diversity regulation can be translated into a structural equation meta-model (Fig. 3). In this meta-model the dotted boxes represent theoretical constructs, the directed arrows represent dependencies, and in this example the model form is static rather than dynamic. In this meta-model, we make no attempt to specify exactly how constructs will be represented in an SEM (with latent, observed, or other kinds of variables), but only present the general forms of the hypothesized dependencies. The intent of the meta-model is to specify structure at the level of abstraction consistent with theory. In this example, the pathways among the constructs are given labels to describe hypothesized causal processes. The assignment of labels to pathways is not required (and may be infeasible in some cases), though a description of the theoretical meaning of all relationships in the model should be made explicit (e.g., Anderson et al. 2007: Table 1).

The meta-model in Fig. 3 indicates that abiotic stress and the disturbance regime are expected to have direct effects on diversity (i.e., direct pathways to diversity) as well as indirect effects/pathways mediated through influences on community biomass. More detailed meta-models could be developed that include, for example, distinctions between resource and nonresource abiotic factors and between community biomass and resource depletion (see discussion in Grace 1999). The form of this meta-model (Fig. 3) is intended to be consistent with the original presentation of the example for which it will be used (Grace and Pugsek 1997).

Some criteria for specifying structural equation models

Grace and Bollen (2006, 2008) describe some of the criteria to be considered when deciding on model specification. Fig. 4 provides a brief summary of some

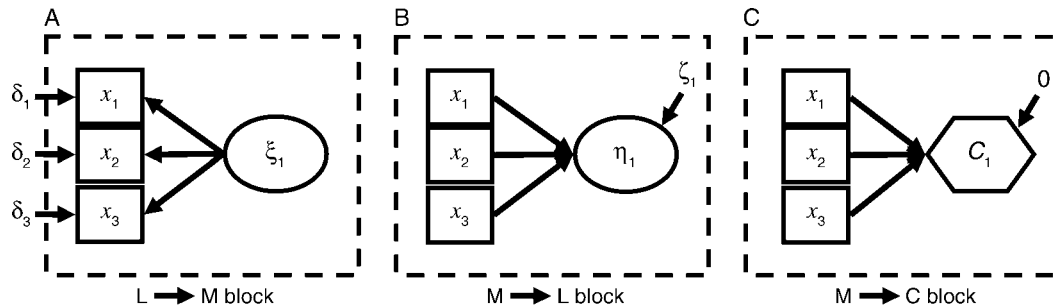

FIG. 4. Presentation of block types showing relationships between observed (manifest, M) variables x_1 – x_3 and latent variables (L) or composites (C). A composite variable is a direct product of some set of causes and is declared to have zero error variance (from Grace and Bollen 2008). In the L → M block, the latent variable is exogenous to the observed variables and is designated as such using the symbol ξ_1 . However, in the M → L block, the latent variable is endogenous and designated with the symbol η_1 . Being endogenous, the variable η_1 possesses an error term ζ_1 . The symbols δ_1 , δ_2 , and δ_3 are the error terms for exogenous variables 1, 2, and 3.

important distinctions. We define a *block* as a basic unit of model design (represented in the figure by the dashed boxes). Three types of blocks are shown, each with distinctive features and each appropriate for different situations depending on the presumed characteristics of the theoretical constructs and the properties of the set of measured indicators (also known as *manifest variables*).

In the L-to-M block type, sometimes referred to as *reflective* (Fig. 4A), causation is presumed to flow from the latent cause to the manifest variables and the indicators in such a block are often referred to as *effect indicators* because they represent observed effects of the unobserved cause. This contrasts with the M-to-L and M-to-C block types (Fig. 4B, C) where the indicators are *causal indicators* and sometimes described as *formative*. Such a block structure is appropriate when the latent process is caused or influenced by the indicators (an extension of the above LISREL equations is needed to accommodate the case of causal indicators.) In the M-to-L block type, we have no measures of the latent factor, but we presume its existence is not entirely determined by the three causal indicators (x_1 – x_3), thus the existence of an additional error term ζ .

In the M-to-C block type, the collective influences of x_1 – x_3 determine the latent variable. Its error variance is specified to be zero because the latent variable is completely determined by the causal indicators. In this case, the latent variable is a *composite variable*. There are two kinds of composites, those for which the loadings from causes have a priori fixed values (e.g., the importance values used in vegetation studies) and those for which the weights are contingent upon the situation. The latter is the type of composite considered in this paper. These composites are analogous to multiple regression predictors in that the weights are derived from a process that maximizes variance explanation in one or more response variables that are influenced by the composite (response variables are not shown in the figure). More complex block structures are possible (Kline 2006, Grace and Bollen 2008), including some where the composites are formed from latent variables.

Models containing composites are typically unidentified and special procedures are needed to estimate these models. Grace and Bollen (2008) describe a *two-stage compositing process* based on the use of partially-reduced form models that can overcome these problems sufficiently to permit the solution of certain cases. First, a composite is not identified unless it is embedded in a larger model and has at least one effect on some endogenous (response) variable. Since a composite has its error variance set to zero, that parameter is not problematic. However, as with latent variables, the scale of the composite has to be set and this will typically involve fixing the parameter of one of the causal indicators to a value of 1.0, meaning the composite has the scale of that indicator. This solution creates a problem for the evaluation of the statistical significances for the causal indicators, however, since not all of their parameters are freely estimated. One approach to evaluating the paths from causal indicators that have fixed values is to use a partially-reduced form model in which the composite is omitted and the direct paths from causal indicators to response variables are evaluated. After evaluation, the results can be used to correctly specify the composites as necessary to represent the causal effects. This leaves only the problem of what to do when there is more than one path flowing out from a composite. The solution to this problem is beyond our scope at the present time and the interested reader is referred to Grace and Bollen (2008:207).

An example

In 1997, Grace and Pugsek conducted a study of a coastal wetland landscape in which they collected data on the relationships of plant diversity and community biomass to variations in stress and disturbance (see Plate 1). One hundred and ninety field plots were studied and indicators for these constructs were measured. The measured indicators and their associations with constructs are shown in Fig. 5 and a summary of the data is in Table 2. In this presentation, we wish to illustrate what the model architectures would be if we assume

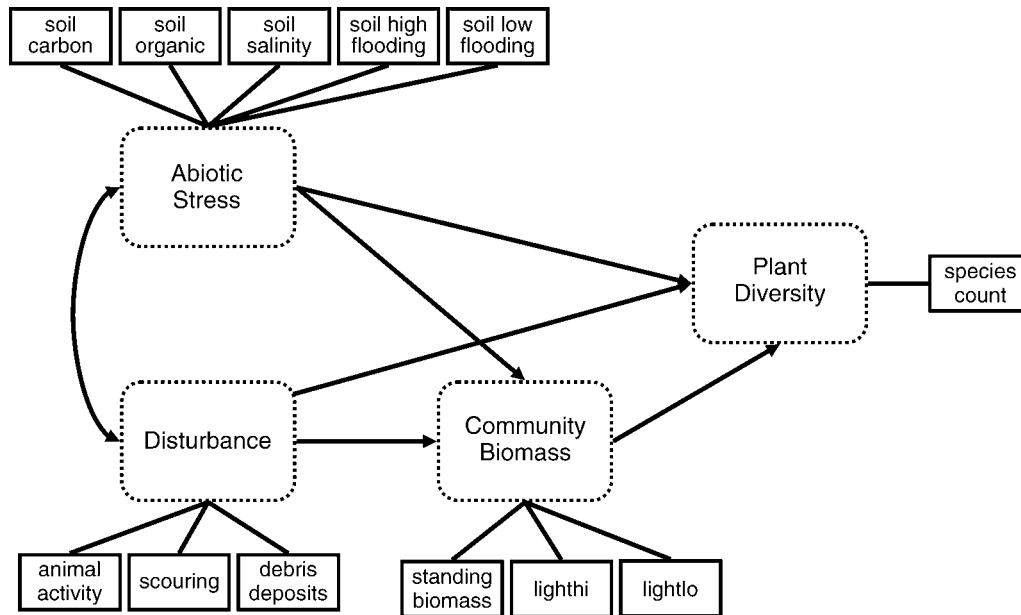

FIG. 5. Associations between measured variables or indicators (in rectangles) and theoretical constructs (in dotted outlines). Note that the causal directions are not specified for relationships between indicators, and constructs are not specified. Variables lighthi and lightlo are two measures of light penetration shown as possible indicators for the construct Community Biomass. Other non-intuitive variables are defined in Table 2.

either that our theoretical constructs should be represented in the classical fashion by treating the indicators as effects (Fig. 4A) or by treating the indicators as causes (Fig. 4B, C).

In classical measurement theory, which derives largely from the study of human personality characteristics, it has generally been assumed that proper constructs are unidimensional and appropriately represented by a

single latent variable with multiple reflective indicators for each construct (Viswanathan 2005). Structural equation models derived from this same tradition are sometimes referred to as *hybrid models* (Kline 2005:74) and for our example would take the form shown in Fig. 6. Since there are no direct arrows between observed variables in this model, it is hypothesized in this case that the complete set of covariances among observed

TABLE 2. Sample correlations and standard deviations for the variables used in the main example (data from Grace and Pugsek [1997]).

Variable	lightlog	light†	%dstb†	species count	masslog	soil carbon†	soil organic†	soil low flooding†	soil high flooding†	soil salinity
lightlog	1.000									
light	0.858	1.000								
%dstb	0.667	0.776	1.000							
species count	-0.251	-0.404	-0.228	1.000						
masslog	-0.699	-0.794	-0.686	0.291	1.000					
soil carbon	0.060	0.157	0.218	0.119	-0.096	1.000				
soil organic	0.012	0.120	0.186	0.132	-0.071	0.973	1.000			
soil low flooding	0.552	0.439	0.249	-0.374	-0.426	-0.170	-0.211	1.000		
soil high flooding	0.547	0.462	0.290	-0.406	-0.466	-0.150	-0.188	0.959	1.000	
soil salinity	0.327	0.321	0.216	-0.292	-0.138	0.249	0.244	0.073	0.052	1.000
Mean	2.85	0.28	2.78	6.95	6.74	1.03	2.32	3.90	3.50	2.62
SD	1.11	0.285	3.29	3.33	1.44	0.605	1.23	1.33	1.27	1.68

Notes: The variable lightlog is the natural log of the percentage of full sunlight reaching the ground surface; light refers to the percentage of full sunlight reaching the ground surface; %dstb refers to the percentage of the area of a plot that had obvious signs of disturbance; species count refers to the number of species in a plot; masslog refers to the natural log of the above-ground plant biomass in a plot; soil carbon refers to the percentage of soil mass that is carbon; soil organic refers to the percentage of soil mass that is organic; soil low flooding refers to the highest elevation in a plot, which is associated with the least level of flooding; soil high flooding refers to the lowest elevation in a plot, which is associated with the greatest level of flooding; and soil salinity refers to the estimated salinity in parts per thousand. The bottom two rows report the mean and standard deviation for each variable. In figures and tables throughout the paper, theoretical constructs and latent variables have initial capitalization, and observed variables are uncapitalized.

† These variables were divided by 10 before analysis.

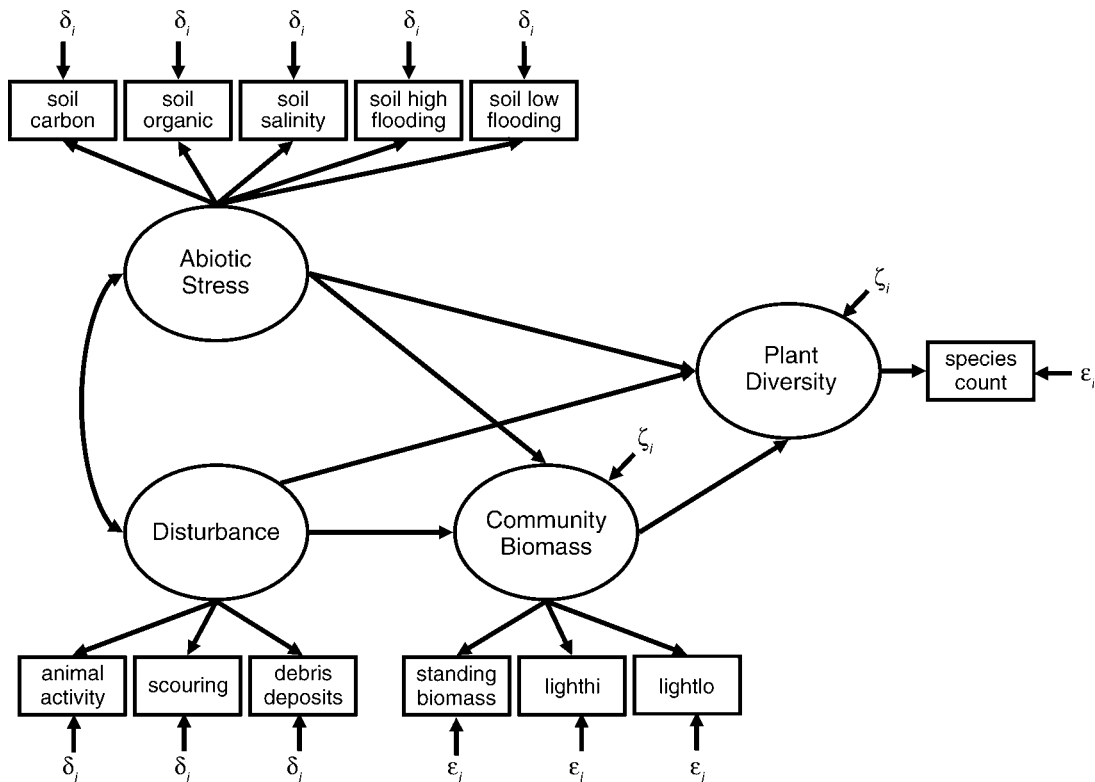

FIG. 6. Example of a structural equation model based on classical measurement theory (which is sometimes known as a hybrid model). Here each theoretical construct is represented by a single latent variable (circle), and all measured variables (rectangles) are represented as effect indicators. Error variables are represented by either δ (for exogenous variables), ϵ (for endogenous variables), or ζ (for endogenous latent variables).

variables can be explained by the interactions among four unmeasured entities as represented by the relationships among the latent variables. If this model adequately describes the processes that have generated the data, the indicators in a block should be expected to be reasonably well correlated with each other and the strengths of intercorrelations should be roughly equal among indicators. These expectations can be used to allow the characteristics of the data to tell us whether our data are consistent with our theoretical formulation.

In this case, if we attempt to solve the model in Fig. 6 using the data from Grace and Pugsek (1997) and some appropriate software (in this case, Mplus; Muthén and Muthén 2008), we are unable to obtain convergence to a solution. This result (along with other diagnostics) indicates that we have a model that is so misspecified that we cannot obtain even approximate parameter estimates. One way out of this dilemma would be through model simplification. Following the historic path analysis tradition, we could choose a subset of the observed variables to build our model, with one variable selected for each construct. While having many merits, particularly parsimony, such an approach ignores much in the SEM tradition that seeks to support causal inference.

In order to develop an appropriate model for our example, we need to consider both theoretical and empirical criteria. We can accomplish this by considering several questions involving theoretical criteria: (1) Do our constructs have multiple dimensions or facets? If so, how do our measures relate to those dimensions? (2) What do we believe to be the direction of causality? Do the indicators derive from a common process or do they combine to form our construct? (3) Are the indicators within a single block interchangeable as if they are replicate measures of the same thing? (4) Do we expect the indicators to necessarily covary? If one indicator was to go up would we expect the other indicators to also go up? Alternatively, do we believe that different indicators in a block are controlled by different processes and not necessarily measures of the same thing?

With regard to empirical considerations, we ask two additional kinds of questions: (5) How strongly and consistently correlated are the indicators in a block? (6) Are there known measurement errors, and if so, do we have any estimates of the reliability of our measures?

Collectively, these questions provide guidance for the specification of models. In the following section, we use these questions selectively to consider how the structural equation meta-model (Fig. 3) and associated indicators

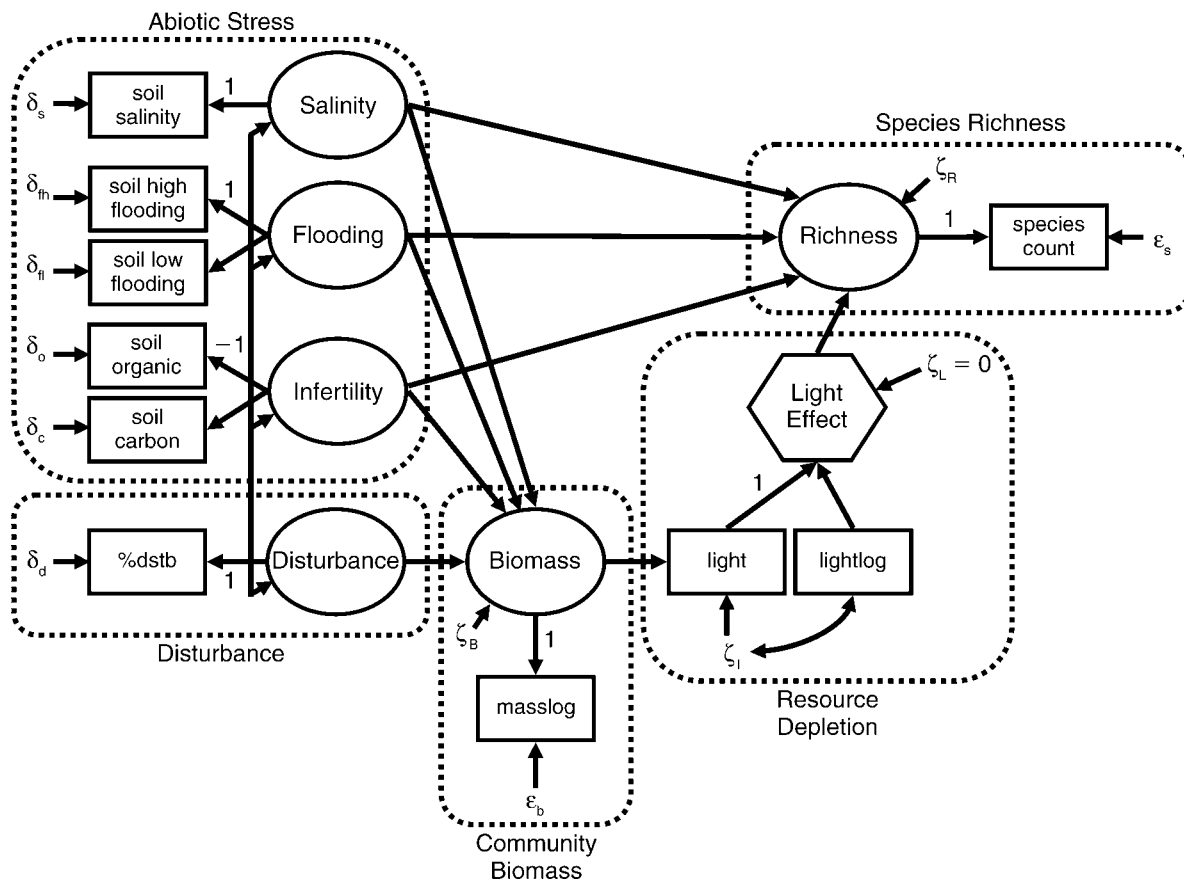

FIG. 7. The initial structural equation model for the main example. In this model, theoretical constructs are shown using dashed, round-edged boxes with the variables used to represent those constructs inside. Single-indicator latent variable blocks were used to represent Richness, Biomass, Disturbance, and Salinity. Flooding and Infertility were each represented using two effect indicators. The Resource Depletion construct was represented using a polynomial regression structure where the model effect of light on richness was of the form $y = x + \log x + e$, where y is the response, x the predictor, and e refers to error. Loadings that were fixed to a value of 1.0 or -1.0 to set the scale for latent or composite variables are shown in the figure. Error variables are represented by either δ (for exogenous variables), ϵ (for endogenous variables), or ζ (for endogenous latent variables). For more information on this model, refer to *Using meta-models to guide specification of structural equation models: Specification of an appropriate structural equation model*.

(Fig. 5) can be translated into an appropriate structural equation model. We do not claim that the model developed is the “true” model, only one for which we have considered many possible architectures and selected one after careful consideration.

Specification of an appropriate structural equation model

Our theoretical description of diversity stated that it consists of multiple dimensions: specifically species richness, life form richness, and evenness. Grace and Pugsek (1997) focused on the richness dimension and we follow suit for simplicity. In this case, a single indicator (a count of the number of species in each plot) measures the dimension species richness. One question we must consider is whether we have a valid measure of species richness. Based on a very substantial literature on this subject, we conclude that a count of the species is consistent with the theoretical meaning of species richness. Another issue to consider is the question of

the reliability (precision) of our measure. Since reliability is a scale-free metric, our primary concern here is with the degree to which our measure correlates with the true values. Undoubtedly there will be some discrepancies among repeated attempts to measure the number of species in plots, which is one way we could estimate reliability. Data from multiple censuses (J. B. Grace, *unpublished data*) indicates that for the community sampled in this study, reliability for these data is approximately 92%. Based on the information available, it would seem appropriate to model the species richness dimension of the construct plant diversity using a latent variable having a single indicator of specified reliability (Fig. 7).

For community biomass, the measures available include an estimate of the maximum standing crop of biomass, plus measures of the degree of shading created by that biomass (in units of percent of full sun reaching the ground surface). There has been some discussion



PLATE 1. Aerial infrared view of a portion of the Pearl River, Louisiana, USA, coastal wetland landscape. Photo credit: U.S. Geological Survey.

about the *validity* of different measures of community biomass for understanding patterns of diversity (Grace 1999). Again, our minimal requirement for a sufficient measure is one that correlates well with the causal variable, an assumption we believe is reasonable for maximum standing crop when studying grasslands (although there are communities for which this assumption would not be reasonable). However, as Grace and Pugsek (1997) concluded, it may be most appropriate to consider the amount of light reaching the ground as a measure of resource depletion rather than community biomass. Based on this reasoning, it would seem appropriate to deviate from our original meta-model to recognize resource depletion as an additional construct in this case. For the construct community biomass we are left with one indicator, standing biomass. Similarly, the construct resource depletion has a single indicator, light penetration.

Both theory and experience tell us that the relationships among biomass, light, and species richness are not necessarily linear and may be unimodal (Grime 1973, Mittelbach et al. 2001, Scheiner and Willig 2005). It is beyond our purpose here to discuss the intricacies of modeling nonlinear pathways (see Stolzenberg 1980, Wall and Amemiya 2000), though it is necessary to describe the structure of the model specification employed in this example. Our examination of relationships in the data, plus our experience in modeling similar situations, led us to represent community biomass using a single-indicator latent variable (correcting for imperfect reliability as described in Grace and Pugsek 1997). Logarithmic transformation of the indicator for biomass

was observed to improve the linearity of its relations with other variables in the model to an acceptable degree. Light, however, required a polynomial regression specification to model its unimodal relationship with richness (Fig. 7). To keep our model as simple as possible for our purposes, only observed variables were used for representing light (i.e., we assume perfect measurement). Consistent with the philosophy of polynomial regression (Heise 1972), two terms (light and its natural logarithm) were included in the model. To capture the combined effects for the two terms in the polynomial relationship, light and its log were treated as causal indicators for a composite variable named the light effect. The result is that the relationship between light and richness is modeled as a second-order polynomial relationship summarized by the path from light effect to richness.

For disturbance, our theoretical definition describes both common and unique aspects associated with different disturbances, with the common aspect being the removal or destruction of community biomass. For this construct we identified three causes of disturbance (animal activity, scouring, and debris deposits), all of which create bare ground. Several lines of thought suggest that these measures are causal indicators instead of effect indicators. First, we do not conceptualize disturbance as a single latent entity, but in this case, something formed from the combined effects of animals, waves, and debris. Second, we would not expect the three indicators to be positively correlated with each other because there is no causal process driving their simultaneous variation. Nor are these indicators well

correlated (data not shown) as would be expected for a set of effect indicators. These lines of evidence suggest the indicators for disturbance are better treated as causal rather than as effects of a common process. In this case, since all three are measured in the same units, bare ground, we used total bare ground from all sources as our single measure of disturbance (Fig. 7). An approximate reliability estimate of 90% was used to specify measurement error for our indicator.

The construct referred to as abiotic stress has the most indicators in this example and they can be sorted among three dimensions of abiotic stress: (1) salinity stress, (2) flooding stress, and (3) infertility. (Note that in this example we distinguish soil infertility from resource depletion, the latter of which results from competitive uptake of resources by other organisms.) Consistent with the treatment in Grace and Pugsek (1997), each of the three dimensions can be represented using a latent variable (Fig. 7). For salinity stress, there exists a single indicator. Multiple measures within plots were taken during data collection and the information from those provides an estimate of reliability (92%) that can be used to specify measurement error. For flooding stress, both maximal and minimal flooding depths were measured in each sample plot and these can be used as multiple indicators for flooding stress. In this case, the consistency between multiple measures provides the estimation of reliability as an integral part of the structural equation model and specification of error quantities is not required. For infertility, soil organic matter estimates can serve as multiple indicators of the quantity of total nutrients in the soil, which would be expected to be low in sandy soil deposits having low organic content and high in peat-rich soils. The indicators available, the percentage of the soil that is organic and the percentage of the soil that is carbon, represent two different analytical approaches to estimating the same thing. It seems appropriate that these two indicators be viewed as effects since they are expected to be comparable under nearly all circumstances, and, in fact, are observed to be highly correlated ($r = 0.97$). Note that these indicators are inversely related to infertility in that soils with low values of soil organic are infertile (thus, the loading in the model relating soil organic to infertility is set to -1 to reverse code the relationship).

SEM results

Estimation of the model shown in Fig. 7 resulted in fairly poor model-data fit ($\chi^2 = 69.98$, $df = 21$, $P < 0.001$). Examination of residuals revealed that there were effects of disturbance and salinity on light. Also, chi-square tests confirmed that two of the originally specified paths (from salinity and infertility to community biomass) could be omitted from the model. The modified model (Fig. 8) was found to have adequate fit ($\chi^2 = 31.75$, $df = 21$, $P = 0.062$; RMSEA = 0.052 with probability of a close fit = 0.43). Consistent with Grace and Pugsek (1997), the added effects of salinity and

disturbance on light can be interpreted as morphological responses by the plants to those conditions. A summary of the numerical results from the analysis of the model shown in Fig. 7 are presented in Table 3. Readers interested in the detailed findings for this system can refer to Grace and Pugsek (1997).

MODELING MULTIFACETED CONSTRUCTS AT A MORE GENERAL LEVEL OF ABSTRACTION

In the previous section, we demonstrated how a meta-model can facilitate the translation of theoretical knowledge into SE models. The model we developed for this example included latent variables with multiple indicators for some of the dimensions of abiotic stress. While such latent variable specification permits a degree of generalization, our SE model (Fig. 8) is a rather specific instantiation of the theory embodied in our meta-model (Fig. 3). For example, in our meta-model we express theoretical interest in abiotic stress but in our SE model, we treat the individual dimensions (salinity, flooding, and infertility) as separate entities. The question remains, therefore, as to how we might examine the overall effects of abiotic stress on community production, resource depletion, and species richness. Bagozzi and Edwards (1998) refer to this as the problem of representing constructs at the appropriate "depth" of generality. There are two main approaches we might use to scale up our analysis so that we can match our SE model better with our meta-model, one involves *second-order latent composites* and the other involves the *aggregation* of indicators.

Modeling with second-order latent composites

A *second-order latent variable* is one whose indicators are other latent variables. Second order latent variables are typically used to represent multifaceted constructs. In our case, we are interested in whether we can use a second-order latent variable to represent abiotic stress, which we have shown to be multidimensional. Before specifying a second-order latent variable, we must first ask whether our dimensions of stress (salinity, flooding, and infertility) are reflective of a higher order factor or whether the dimensions work together formatively to cause the total stress effect. A simple diagnostic we could use in that decision is to ask whether we think salinity, flooding, and soil infertility would necessarily vary together. Salinity is determined primarily by distance from the ocean while flooding is determined by variations in elevation. Thus, these are not reflective of a common process and will not be consistently correlated with each other. We might expect that soil organic matter could covary with flooding and salinity, but we would still think that its contribution to stress is causal instead of reflective. Collectively, this evidence argues in favor of interpreting the dimensions of abiotic stress to be causes of stress that work in combination.

Fig. 9 illustrates the model structure we get if we specify a second-order latent variable representing the

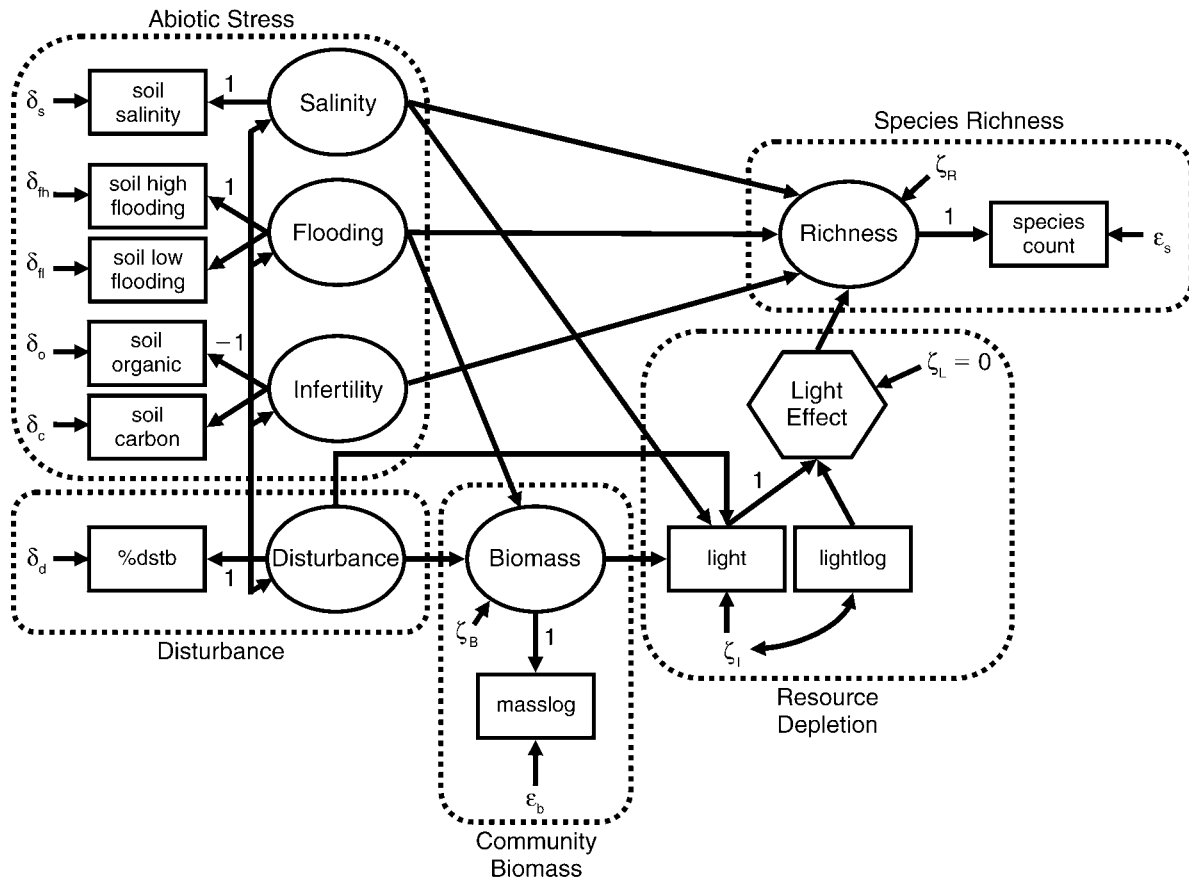

FIG. 8. Revised model based on estimation results for the model in Fig. 7. Diagnostics indicated that additional effects of Salinity and Disturbance on light were necessary and appropriate. Paths from Salinity and Infertility to Biomass were not required and were removed from the model. Model $\chi^2 = 29.58$, $df = 19$, $P = 0.057$; RMSEA = 0.054 with probability of a close fit = 0.39). Error variables are represented by either δ (for exogenous variables), ϵ (for endogenous variables), or ζ (for endogenous latent variables).

combined causal influences of all three stress dimensions on species richness (the species filter). Because our second-order latent (named Species Filter to represent the process we believe it captures) has a zero error variance and is entirely formed from its indicators, we classify it as a latent construct (Grace and Bollen 2008). In this case, since only the flooding dimension of abiotic stress affects biomass and only the salinity dimension affects light, there is no need to represent their effects using second-order latent variables. We conclude, therefore, that the architecture shown in Fig. 9 is appropriate for this situation (a more complete exposition of this result is given in the Appendix). Select results for this model are given in Table 4.

The statistical results obtained for the model in Fig. 9 are the same as for the model without the second-order latent variable except that the path from salinity to species filter is constrained to a fixed value of 1.0 (for identification purposes) and now we have an estimate for the path from species filter to richness (unstandardized value = -0.655 with a standard error of 0.128 and a P value of <0.001). In essence, the model shown in Fig.

8 is a partially reduced form version of the model in Fig. 9, which explains why the results are so similar (Grace and Bollen 2008).

Aggregation of indicators

Bagozzi and Heatherton (1994) and Bagozzi and Edwards (1998) have described another approach that can be used to model multifaceted constructs. When working with multifaceted constructs, there exists a hierarchy of conceptual levels that may be of interest (e.g., the level of the dimension, the “facet” level, vs. the level of the construct, the “global” level). One way to represent models at different levels of generality or conceptual depth involves the aggregation of indicators. A full discussion of the criteria by which one would decide on the appropriate level of aggregation is beyond our purpose here (see Bagozzi and Edwards 1998); however, we can illustrate the aggregation approach for our example by considering a model in which we aggregate salinity, flooding, and infertility into a single index so as to represent their collective effects (Fig. 10).

TABLE 3. SEM results for the model in Fig. 8.

Pathway	Estimate	SE	Critical ratio	<i>P</i>
Species Richness ← Light Effect	-9.024	1.288	-7.005	<0.001
Species Richness ← Infertility	-0.602	0.164	-3.670	<0.001
Species Richness ← Flooding	-1.032	0.181	-5.696	<0.001
Species Richness ← Salinity	-0.655	0.128	-5.120	<0.001
light ← Biomass	-0.133	0.014	-9.446	<0.001
light ← Salinity	0.029	0.006	4.544	<0.001
light ← Disturbance	0.025	0.006	4.449	<0.001
Biomass ← Flooding	-0.348	0.056	-6.180	<0.001
Biomass ← Disturbance	-0.272	0.023	-11.911	<0.001
Light Effect ← light	1.000	NA	NA	NA
Light Effect ← lightlog	-0.243	0.024	-10.116	<0.001
species count ← Species Richness	1.0	NA	NA	NA
masslog ← Biomass	1.0	NA	NA	NA
%dstb ← Disturbance	1.0	NA	NA	NA
soil carbon ← Infertility	-0.480	0.008	-57.56	<0.001
soil organic ← Infertility	-1.0	NA	NA	NA
soil high flooding ← Flooding	1.000	0.001	>100	<0.001
soil low flooding ← Flooding	1.000	NA	NA	NA
soil salinity ← Salinity	1.0	NA	NA	NA
Flooding ↔ Infertility	0.291	0.115	2.533	0.01
Salinity ↔ Flooding	0.119	0.154	0.770	>0.05
Flooding ↔ Disturbance	1.200	0.313	3.833	<0.001
Salinity ↔ Infertility	-0.505	0.154	-3.281	<0.001
Infertility ↔ Disturbance	-0.767	0.298	-2.576	<0.05
Salinity ↔ Disturbance	1.178	0.407	2.892	<0.01

Notes: Model χ^2 was 31.75, $df = 21$, $P = 0.062$. The root mean square error of approximation (RMSEA) was 0.052 with probability of a close fit = 0.43. R^2 values: species richness, 0.43; light, 0.82; Biomass, 0.67. Arrows indicate direction of causation. "NA" indicates nonapplicable values associated with "fixed" parameters.

The process of aggregation is relatively straightforward and typically involves summing or averaging indicator scores. In our case, this involves two stages. If we examine Fig. 8, we recall that we have two indicators for flooding and two for infertility. Aggregation at the dimension level would involve combining the information from the individual indicators for a dimension into a single indicator. For flooding, our two indicators are in the same units, so averaging their values gives us an indicator of average flooding depth. For infertility, our indicators are not in the same units. We could convert organic to carbon using literature values, but in this case we relativized both indicators (as proportion of their maximum values) and then averaged them. For the second stage of aggregation, the remaining indicators were relativized and then all were summed into a single index of total stress. For this index, the indicator for infertility was assigned negative values since high levels of stress are associated with low levels of organic. Following this process of aggregation, we were able to produce a model in which stress is represented by a single latent variable having one indicator, an index of stress with each dimension weighted equally. For this example, we considered the measurement error for this combined index to be small and set the error variance to zero.

As Bagozzi and Heatherton (1994) point out, aggregation across dimensions for multifaceted constructs can produce indices that fail to capture the combined influences of the construct if the multiple facets of a

construct have different effects elsewhere in the system. Despite this, the conceptual simplicity achieved with an overall index of stress might still make aggregated models useful if the loss of information is not too great. Results for the aggregated model (Fig. 10) are presented in Table 5 and can be compared to those for the nonaggregated model in Table 4 to evaluate the effects of aggregation. R^2 values for endogenous variables in nonaggregated (and aggregated) models were as follows: Richness, 0.43 (0.41); light, 0.82 (0.80); and Biomass, 0.67 (0.60). While we provide no formal test results here, we can see that the results for richness and light were similar for the two models, while for biomass, there was a modest loss of variance explanation associated with the aggregated model. Examination of path coefficients (Tables 4 and 5) shows that the standardized effects of stress in the aggregated model are modestly but consistently lower than in the nonaggregated model. At the same time, coefficients for some of the other pathways also differ between models, though in an inconsistent way.

The choice between using a model based on compositing (Fig. 9) vs. aggregation (Fig. 10) is somewhat complex. On the one hand, total aggregation for abiotic stress yields a simpler model that fits the data more closely and provides a single index for abiotic stress. On the other hand, there is a loss of information from aggregation of dimensions in a multifaceted construct, as well as some distortion of the relative effects in the model. We do not wish to condemn or endorse either

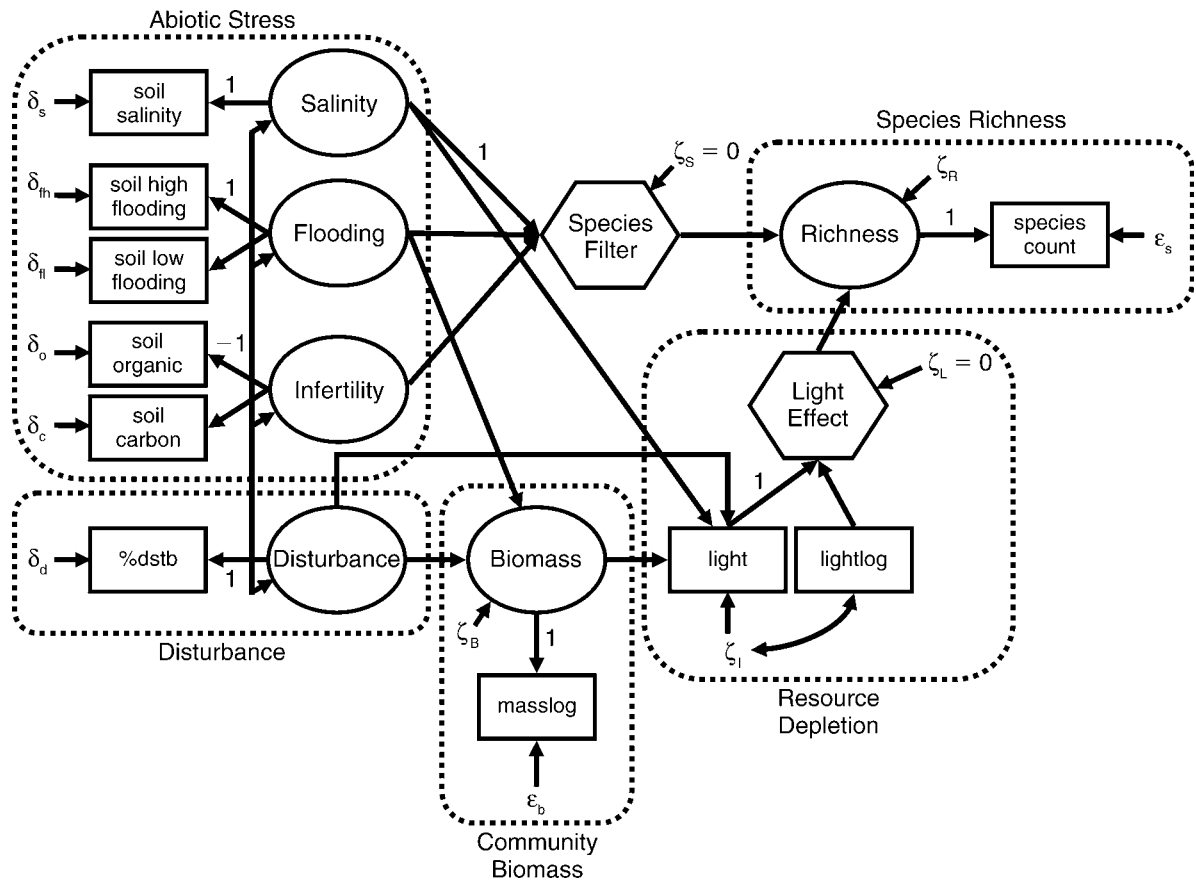

FIG. 9. Modification of the model in Fig. 8 with an added second-order latent composite (Species Filter) that represents the collective effects of the three dimensions of Abiotic Stress (Salinity, Flooding, and Infertility) on Richness. The model in Fig. 8 serves as the partially reduced form of this model. Reference to results for the partially reduced form model (Table 3) permits the pathways contributing to the composite Species Filter to be tested for significance.

approach here since our purpose is to illustrate different ways of modeling multifaceted constructs. Further, we can combine both approaches by using compositing to set the weights for aggregated indices, improving their specificity. Both approaches can be useful for generalization, with the former being preferable for cases where the multiple facets in a construct have widely differing effects in the system and the latter being preferable where they do not. Also, both models can be derived from our meta-model, and both can serve to inform our theory.

RELATING SEM RESULTS BACK TO THE META-MODEL

Qualitative comparisons

There are at least two levels of precision by which we can relate our SEM findings back to our meta-model. The first is qualitative. If we consider how our results compare to our initial meta-model (Fig. 3), they suggest a revised meta-model (Fig. 11). First, making a narrow distinction between community biomass itself and its effects on resource depletion was important, as the indicators for these two concepts were not interchangeable.

TABLE 4. Coefficients for key paths in Fig. 9.

Pathway	Unstandardized estimates	Standardized estimates
Species Richness ← Species Filter	-0.655	-0.58
Species Richness ← Light Effect	-9.024	-0.42
light ← Salinity	0.029	0.17
light ← Disturbance	0.025	0.28
light ← Biomass	-0.133	-0.62
Biomass ← Disturbance	-0.272	-0.66
Biomass ← Flooding	-0.348	-0.33

Notes: Estimated R^2 values for endogenous variables: Richness, 0.43; light, 0.82; Biomass, 0.67. Model $\chi^2 = 31.75$, $df = 21$, $P = 0.062$. Arrows indicate direction of causation.

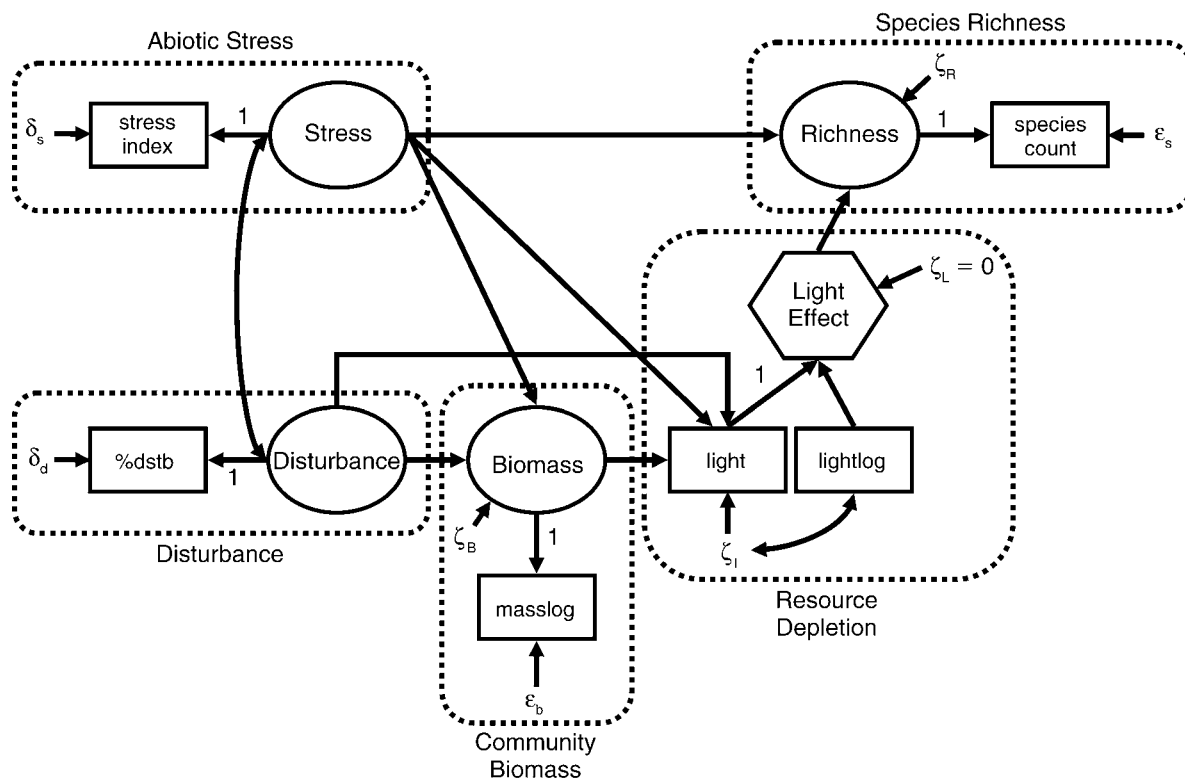

FIG. 10. Model in which an aggregated index of abiotic stress is used to represent that construct. See *Modeling multifaceted constructs at a more general level of abstraction: Aggregation of indicators* for a description of the procedures used for aggregation.

able (a criterion for multiple indicators of a latent factor). Second, our results raise questions about whether we would expect to find a direct effect of disturbance on species richness in future studies. We might expect that selective extinction effects (our interpretation of this pathway) could occur in certain circumstances, so we should continue to anticipate them, but they do not appear to be a constant feature. Third, we found evidence for effects of abiotic stress and disturbance on plant morphology that altered the biomass-light relationship. In both disturbed and stressful habitats, plants tended to have a more upright morphology and to permit more light penetration per unit biomass than in undisturbed, less stressed locations. Such effects appeared to be rather prominent suggesting that morphological responses (which could be of various sorts in

different situations) should be built into our theoretical expectations. These inferences are unaffected by whether we use results from a compositing approach vs. an aggregation of indicators.

Semi-quantitative comparisons

A second level of precision by which we might relate our SEM findings back to our meta-model is semi-quantitative. Scientists are commonly interested in the relative importances of different processes and ecologists might ask, for example, "What are the relative importances of different processes controlling species richness in my system?" To consider how we might use our numerical results to compare different pathways in our model, we need to mention the basic issue of coefficient interpretation.

TABLE 5. Coefficients for key paths in Fig. 10.

Pathway	Unstandardized estimates	Standardized estimates
Species Richness ← Stress	-4.751	-0.53
Species Richness ← Light Effect	-9.495	-0.43
light ← Stress	0.111	0.14
light ← Disturbance	0.032	0.37
light ← Biomass	-0.113	-0.53
Biomass ← Disturbance	-0.298	-0.72
Biomass ← Stress	-0.724	-0.20

Notes: Estimated R^2 values for endogenous variables: Richness, 0.41; light, 0.80; Biomass, 0.60. Model $\chi^2 = 0.578$, $df = 2$, $P = 0.749$. Arrows indicate direction of causation.

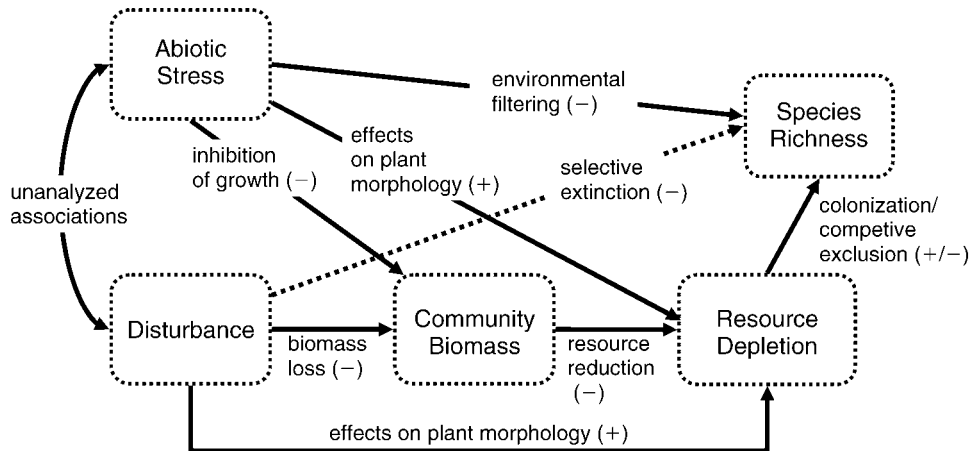

FIG. 11. Revised meta-model based on the results of the SEM analyses. An additional construct, Resource Depletion, has been added to better delineate the theoretical distinction between the biomass in the community sample and the shading it produces. This change in the revised model reflects the originally unanticipated effects of both Abiotic Stress and Disturbance on Resource Depletion through effects on plant morphology. Plus and minus signs refer to positive and negative effects.

Grace and Bollen (2005) discuss several issues related to the interpretation of path coefficients in regression and structural equation models. In this paper, we have the additional matter of interpreting coefficients relating composites (light effect and species filter) to richness. To briefly describe the challenges (see Pedhazur [1997] for a deeper consideration), unstandardized coefficients (which are in raw units, e.g., species lost per unit salinity increase) are the fundamental product of most SEM analyses. The challenge is to compare effects of different factors on common or different responses using these disparate scales. Standardized coefficients, which are the typical devices used by subject matter specialists for comparing pathways, are most often calculated by multiplying the unstandardized parameter values by the ratio of the standard deviations of the variables on either end of a path (e.g., SD_x/SD_y). There are a number of cautions, however, for using standardized coefficients.

Path coefficients in structural equation models are best thought of as prediction coefficients. We can express this notion through a hypothetical question, "If we vary a predictor by some amount while holding constant all other variables except the response variable of interest, how much would it respond?" For unstandardized coefficients, interpretations are fairly straightforward. For standardized coefficients, there are some challenges to interpretation. First, standard deviations are not constant units; they can differ for any given variable from sample to sample. Second, the use of standard deviations depends on the assumption of a normal distribution. For these reasons, some statisticians do not recommend the use of standardized coefficients for interpretations, particularly when comparing among samples or studies. Sewell Wright (1960) and John Tukey (1954) debated this point and there are still divided opinions. Simply put, standardized coefficients are handy for certain kinds of comparisons, but

have a less precise meaning than unstandardized coefficients.

Grace and Bollen (2005) have proposed an alternative standardization procedure, the "relevant range standardization." For each parameter in a model, investigators specify a range of variation over which the observed relationship is expected to hold. Unstandardized coefficients are then multiplied by the ratio of the ranges instead of the ratio of the standard deviations for each path. These range-standardized coefficients predict changes in terms of proportions of the ranges of variation, which is conceptually related to standardizing by standard deviations, but anchored to a more considered choice of scale. While not a perfect solution to the problem of comparing path coefficients, this alternative procedure can clarify the meaning of the values used and reduce some sources of error. When variable distributions are approximately normal, sample sizes are large, and the observed ranges are the ones that are relevant, conventional standardized coefficients are comparable to range-standardized values and both can be interpreted in similar fashion.

Coefficients involving composites deserve additional explanation. When standardized, these coefficients can be interpreted as the predicted range responses that could be maximally caused by the collective effects of the elements making up the composite. These values, understood in this way, are analogous to the other path coefficients described. For the coefficient relating richness to light effect, we have an estimate of the standardized relationship between what can be thought of as a multiple regression predictor (the composite variable light effect) and the variable it is constructed to predict (species richness). What is different is that richness is first increasing and then decreasing across the range of light levels. We cannot think of the

coefficient in this case as expressing the variation in richness across a range of values for light, only across a range of values for the multiple regression predictor (see Stolzenberg [1980] for further discussion of this topic).

As Kline (2005:122) describes, the interpretation of standardized path coefficients is imprecise and best thought of as semi-quantitative. It is possible to use either bootstrapping or Markov chain Monte Carlo methods to estimate standard errors for standardized path coefficients. However, direct statistical comparisons would have to be made with great caution because the units are not strictly comparable. Relating results from our SEM analyses back to our theory, and therefore the meta-model, will tend to be somewhat imprecise and subjective to a degree. However, both the use of composites and aggregation can potentially aid such comparisons by allowing us to summarize our results at higher levels of abstraction possible with simple latent variables.

CONCLUSIONS

Generalizing about ecological systems is challenging. Part of the challenge comes from the characteristics of the theoretical concepts themselves. SEM can be a substantial asset for the study of ecological systems, but care is required for proper model specification. Non-classical specifications involving causal indicators and composites, as well as methods such as aggregation, will often be both appropriate and necessary to represent the general ecological ideas that unify the study of communities and ecosystems. Such alternative specifications can also facilitate our ability to relate the results from SEM analyses back to the level of abstraction in our theories. Meta-models can help with both of these enterprises. Meta-modeling may also prove to be an aid to comparisons among systems and generalization by providing a formal framework that helps to bridge the gap between ecological theory and ecological data.

ACKNOWLEDGMENTS

We thank Evan Weiher and three anonymous reviewers for constructive comments on an earlier draft of the manuscript. This work was supported, in part, by funding from the USGS Global Change Program. The use of trade names is for descriptive purposes only and does not imply endorsement by the U.S. Government. This manuscript is based on work done by S. M. Scheiner while serving at the National Science Foundation. The views expressed in this paper do not necessarily reflect those of the National Science Foundation or the United States Government.

LITERATURE CITED

- Anderson, T. M., M. E. Ritchie, E. Mayemba, S. Eby, J. B. Grace, and S. J. McNaughton. 2007. Forage nutritive quality in the Serengeti ecosystem: the roles of fire and herbivory. *American Naturalist* 170:343–357.
- Arhonditsis, G. B., C. A. Stow, L. J. Steinberg, M. A. Kenney, R. C. Lathrop, S. J. McBride, and K. H. Reckhow. 2006. Exploring ecological patterns with structural equation modeling and Bayesian analysis. *Ecological Modeling* 192: 385–409.
- Bagozzi, R. P. 2007. On the meaning of formative measurement and how it differs from reflective measurement. *Psychological Methods* 12:229–237.
- Bagozzi, R. P., and J. R. Edwards. 1998. A general approach for representing constructs in organizational research. *Organizational Research Methods* 1:45–87.
- Bagozzi, R. P., and T. F. Heatherton. 1994. A general approach to representing multifaceted personality constructs: application to state self-esteem. *Structural Equation Modeling* 1:35–67.
- Bollen, K. A. 1989. *Structural equations with latent variables*. John Wiley and Sons, New York, New York, USA.
- Bollen, K. A. 2002. Latent variables in psychology and the social sciences. *Annual Review of Psychology* 53:605–634.
- Bollen, K. A. 2007. Interpretational confounding is due to misspecification, not to type of indicator. Comment on Howell, Breivik, and Wilcox (2007). *Psychological Methods* 12:219–228.
- DeVellis, R. F. 2003. *Scale development*. Second edition. Sage Publishers, Thousand Oaks, California, USA.
- Diamantopoulos, A., P. Riefler, and K. Roth. 2008. Advancing formative measurement models. *Journal of Business Research* 58:1203–1218.
- Diamantopoulos, A., and H. M. Winklhofer. 2001. Index construction with formative indicators: an alternative to scale development. *Journal of Marketing Research* 38:269–277.
- Edwards, J. R. 2001. Multidimensional constructs in organizational behavior research: an integrative analytical framework. *Organizational Research Methods* 4:144–192.
- Grace, J. B. 1999. The factors controlling species density in herbaceous plant communities: an assessment. *Perspectives in Plant Ecology, Evolution and Systematics* 2:1–28.
- Grace, J. B. 2006. *Structural equation modeling and natural systems*. Cambridge University Press, Cambridge, UK.
- Grace, J. B., and K. A. Bollen. 2005. Interpreting the results from multiple regression and structural equation models. *Bulletin of the Ecological Society of America* 86:283–295.
- Grace, J. B., and K. A. Bollen. 2006. The interface between theory and data in structural equation models. USGS Open-File Report. (<http://pubs.usgs.gov/of/2006/1363/>)
- Grace, J. B., and K. A. Bollen. 2008. Representing general theoretical concepts in structural equation models: the role of composite variables. *Environmental and Ecological Statistics* 15:191–213.
- Grace, J. B., and J. E. Keeley. 2006. A structural equation model analysis of postfire plant diversity in California shrublands. *Ecological Applications* 16:503–514.
- Grace, J. B., and B. Pugsek. 1997. A structural equation model of plant species richness and its application to a coastal wetland. *American Naturalist* 149:436–460.
- Grime, J. P. 1973. Competitive exclusion in herbaceous vegetation. *Nature* 242:344–347.
- Heise, D. R. 1972. Employing nominal variables, induced variables, and block variables in path analyses. *Sociological Methods and Research* 1:147–173.
- Irwin, R. E. 2006. The consequences of direct versus indirect species interactions to selection on traits: pollination and nectar robbing in *Ipomopsis aggregata*. *American Naturalist* 167:315–328.
- Jarvis, C. B., S. B. MacKenzie, and P. M. Podsakoff. 2003. A critical review of construct indicators and measurement model misspecification in marketing and consumer research. *Journal of Consumer Research* 30:199–218.
- Kearney, M., and W. P. Porter. 2006. Ecologists have already started rebuilding community ecology from functional traits. *Trends in Ecology and Evolution* 21:481–482.
- Keeley, J. E. 1991. Seed germination and life history syndromes in the California chaparral. *Botanical Review* 57:81–116.
- Keeley, J. E., M. Baer-Keeley, and C. J. Fotheringham. 2005. Alien plant dynamics following fire in mediterranean-climate

- California shrublands. *Ecological Applications* 15:2109–2125.
- Keeley, J. E., T. Brennan, and A. H. Pfaff. 2008. Fire severity and ecosystem responses following crown fires in California shrublands. *Ecological Applications* 18:1530–1546.
- Kline, R. B. 2005. Principles and practice of structural equation modeling. Second edition. Guilford Press, New York, New York, USA.
- Kline, R. B. 2006. Reverse arrow-dynamics: formative measurement models and feedback loops. Pages 43–68 in G. R. Hancock and R. O. Mueller, editors. A second course in structural equation modeling. Information Age Publishing, Greenwich, Connecticut, USA.
- Lawton, J. H. 1999. Are there general laws in ecology? *Oikos* 84:177–192.
- Lee, S. Y. 2007. Structural equation modeling: a Bayesian approach. John Wiley and Sons, New York, New York, USA.
- Li, R., S.-W. Tsaih, K. Shockley, I. M. Stylianou, J. Wergedal, B. Paigen, and G. A. Churchill. 2006. Structural model analysis of multiple quantitative traits. *PLoS Genetics* 2:e114.
- MacCallum, R. C. 1995. Model specification. Pages 16–36 in R. H. Hoyle, editor. Structural equation modeling. Sage Publications, Thousand Oaks, California, USA.
- MacKenzie, S. B., P. M. Podsakoff, and C. B. Jarvis. 2005. The problem of measurement model misspecification in behavioral and organizational research and some recommended solutions. *Journal of Applied Psychology* 90:710–730.
- McGill, B. J., B. J. Enquist, E. Weiher, and M. Westoby. 2006. Rebuilding community ecology from functional traits. *Trends in Ecology and Evolution* 21:178–185.
- Mittelbach, G. G., C. F. Steiner, S. M. Scheiner, K. L. Gross, H. L. Reynolds, R. B. Waide, M. R. Willig, S. I. Dodson, and L. Gough. 2001. What is the observed relationship between species richness and productivity? *Ecology* 82:2381–2396.
- Muthén, L. K., and B. O. Muthén. 2008. Mplus user's guide. Muthén and Muthén, Los Angeles, California, USA.
- Nunnally, J. C., and I. H. Bernstein. 1994. Psychometric theory. McGraw-Hill, New York, New York, USA.
- Pearl, J. 2000. Causality. Cambridge University Press, Cambridge, UK.
- Pedhazur, J. 1997. Multiple regression in behavioral research. Third edition. Harcourt Brace College Publishers, New York, New York, USA.
- Pickett, S. T. A., J. Kolasa, and C. G. Jones. 2007. Ecological understanding: the nature of theory and the theory of nature. Second edition. Elsevier, New York, New York, USA.
- Pugesek, B. H., A. Tomer, and A. von Eye. 2003. Structural equation modeling. Cambridge University Press, Cambridge, UK.
- Raftery, A. E. 1993. Bayesian model selection in structural equation models. Pages 163–180 in K. A. Bollen and J. S. Long, editors. Testing structural equation models. Sage Publishers, Beverly Hills, California, USA.
- Raykov, T., and G. A. Marcoulides. 2006. A first course in structural equation modeling. Lawrence Erlbaum Associates, Mahway, New Jersey, USA.
- Rupp, A. A., D. K. Dey, and B. D. Zumbo. 2004. To Bayes or not to Bayes, from whether to when: applications of Bayesian methodology to modeling. *Structural Equation Modeling* 11: 424–451.
- Scheiner, S. M. 2004. Experiments, observations, and other kinds of evidence. Pages 51–71 in M. L. Taper and S. R. Lele, editors. The nature of scientific evidence. University of Chicago Press, Chicago, Illinois, USA.
- Scheiner, S. M., R. J. Mitchell, and H. S. Callahan. 2000. Using path analysis to measure natural selection. *Journal of Evolutionary Biology* 13:423–433.
- Scheiner, S. M., and M. R. Willig. 2005. Developing unified theories in ecology as exemplified with diversity gradients. *American Naturalist* 166:458–469.
- Scheines, R., R. Hoijtink, and A. Boomsma. 1999. Bayesian estimation and testing of structural equation models. *Psychometrika* 64:37–54.
- Schumacker, R. E., and R. G. Lomax. 1996. A beginners's guide to structural equation modeling. Lawrence Erlbaum Associates, Mahway, New Jersey, USA.
- Shipley, B. 2000. Cause and correlation in biology. Cambridge University Press, Cambridge, UK.
- Simberloff, D. 2004. Community ecology: Is it time to move on? *American Naturalist* 163:787–799.
- Spearman, C. 1904. General intelligence, objectively determined and measured. *American Journal of Psychology* 15:201–293.
- Stolzenberg, R. M. 1980. The measurement and decomposition of causal effects in nonlinear and nonadditive models. *Sociological Methodology* 11:459–488.
- Tomer, A. 2003. A short history of structural equation models. Pages 85–125 in B. H. Pugesek, A. Tomer, and A. von Eye, editors. Structural equation modeling. Cambridge University Press, Cambridge, UK.
- Tonsor, S. J., and S. M. Scheiner. 2007. Plastic trait integration across a CO₂ gradient in *Arabidopsis thaliana*. *American Naturalist* 169:E119–E140.
- Tukey, J. W. 1954. Causation, regression, and path analysis. Pages 35–66 in O. Kempthorne, T. A. Bancroft, J. W. Gowen, and J. D. Lush, editors. Statistics and mathematics in biology. Iowa State College Press, Ames, Iowa, USA.
- Van Gigch, J. P. 1991. System design modeling and metamodeling. Springer-Verlag, Berlin, Germany.
- Vile, D., B. Shipley, and E. Garnier. 2006. A structural equation model to integrate changes in functional strategies during old-field succession. *Ecology* 87:504–517.
- Viswanathan, M. 2005. Measurement error and research design. Sage Publishers, Thousand Oaks, California, USA.
- Wall, M. M., and Y. Amemiya. 2000. Estimation for polynomial structural equation models. *Journal of the American Statistical Association* 95:929–940.
- Wootton, J. T. 2002. Indirect effects in complex ecosystems: recent progress and future challenges. *Journal of Sea Research* 48:157–172.
- Wright, S. 1918. On the nature of size factors. *Genetics* 3:367–374.
- Wright, S. 1921. Correlation and causation. *Journal of Agricultural Research* 10:557–585.
- Wright, S. 1934. The method of path coefficients. *Annals of Mathematical Statistics* 5:161–215.
- Wright, S. 1960. Path coefficients and path regression: Alternative or complementary concepts. *Biometrics* 16:189–202.

APPENDIX

Further exposition on modeling with a second-order composite (*Ecological Archives* M080-002-A1).